

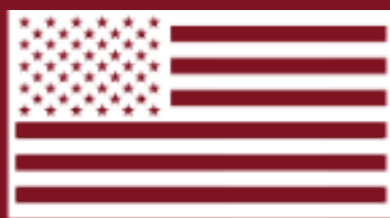

**COMMERCIAL FURNITURE**

**OUTDOOR + INDOOR**

**QUICKSHIP  
2025**



**[WWW.BUMOUTDOOR.COM](http://WWW.BUMOUTDOOR.COM)**







**ONE OF  
NORTH  
AMERICA'S  
LARGEST  
INVENTORY OF  
COMMERCIAL  
PATIO FURNITURE  
FOR:**

**RESTAURANTS**

**HOTELS**

**CONDO TERRACES**

**GOLF COURSES**

**PRIVATE CLUBS**

**EDUCATIONAL SETTINGS**

**OUTDOOR MEETING SPACES**

**AMUSEMENT PARKS**

**MUNICIPAL PARKS**

**CORPORATE OUTDOOR SPACES**

**RETIREMENT RESIDENCE PATIOS**

**RESIDENTIAL PATIOS**



## QUICKSHIP 2025 TABLE OF CONTENTS

ICON LEGEND.....	8
ARMCHAIRS .....	9
ARMCHAIR CUSHIONS .....	26
SIDE CHAIRS .....	27
SIDE CHAIR CUSHIONS .....	44
BAR STOOLS.....	45
TABLES: DINING HEIGHT.....	66
TABLES: BAR HEIGHT .....	85
TABLETOPS.....	91
DINING BASES.....	98
BAR BASES.....	102
LOUNGE SEATING .....	105
LOUNGE CUSHIONS.....	129
LOUNGE SUN BEDS.....	131
LOUNGE TABLES.....	133
COMPLEMENTS.....	141
SHADE .....	148
PLANTERS .....	162
FLAME .....	170
SWATCHES .....	177
TERMS & CONDITIONS .....	181



Our chairs are tested and rated to hold 300 lbs



# QUICKSHIP 2025

## ICON LEGEND



Special Order Colors  
Expect 12-16 Weeks for delivery



Specially Treated for High Salinity  
Environments



Non Slip Replaceable Feet



Stackable



Nesting



Umbrella Hole



Assembly Required



Adjustable Feet



ADA Compliant



Sanibel

All Welded Aluminum Frame, one-piece Quick Dry Foam padded sling seat/back, E-Plated Powder Coat finish

LIST: \$490 EA.    SELL: \$320 EA.

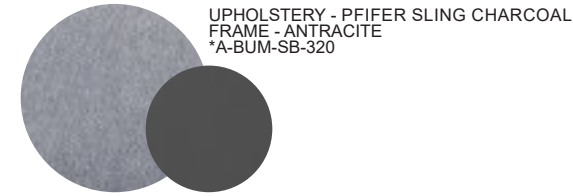
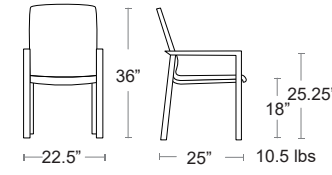

UPHOLSTERY - PFIFER SLING CHARCOAL  
FRAME - ANTRACITE  
\*A-BUM-SB-320



# ARMCHAIRS



## Capri Bucket

Black All Weather Rope back & arms. Antracite round tubular aluminum E-Plated Powder Coat frame, Textaline seat cushion

**LIST: \$470 EA.    SELL: \$305 EA.**

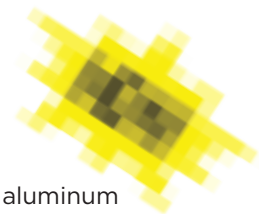
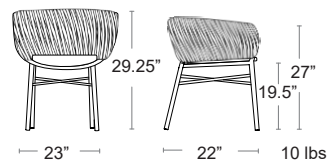

# ARMCHAIRS



## ReCLIPS

Stackable chairs with plastic slats made from 97% household recycled polypropylene + color pigments + UV protection, clipped on a E-Plated Powder Coat aluminum frame with optional Bamboo arm rests.

**LIST: \$450 EA.    SELL: \$295 EA.**

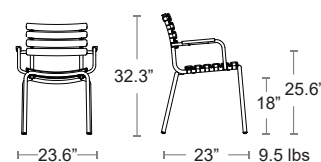

-  SKY BLUE  
\*A-HOUE-22302-1414-14
-  BLACK  
\*A-HOUE-22302-2024-24
-  DARK GREY  
\*A-HOUE-22302-7026-26
-  OLIVE GREEN  
\*A-HOUE-22302-2727-27



BAMBOO ARMS available FOR ALL COLORSS  
\*A-HOUE-BAMBOO ARM REST-03

**LIST: \$18 PAIR**

**SELL: \$12 PAIR**



# ARMCHAIRS



## Marco Sling

Square tubular aluminum frame, E-Plated Powder Coat finish, Batyline Seat & Back, Polywood Armrests

LIST: \$380 EA.    SELL: \$250 EA.

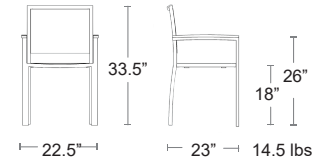
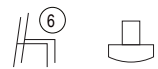

# ARMCHAIRS



## Marco Polywood

Square tubular aluminum frame, E-Plated Powder Coat finish, Polywood Seat, Back & Armrests

LIST: \$380 EA.    SELL: \$250 EA.

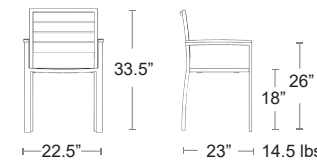
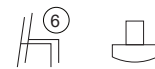



# ARMCHAIRS



## Marco Wicker

Square tubular aluminum frame, E-Plated Powder Coat finish, Viro Wicker Seat & Back, Polywood Armrests

LIST: \$380 EA.    SELL: **\$250 EA.**

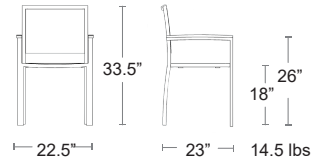
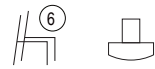

# ARMCHAIRS



## Adico #508

Tubular steel frame, Solid steel seat and back, E-plated Powder Coat finish

LIST: \$340 EA.    SELL: **\$220 EA.**

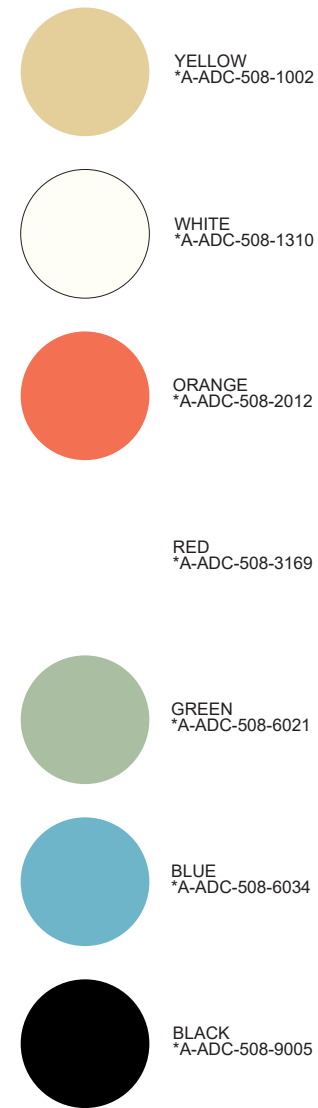
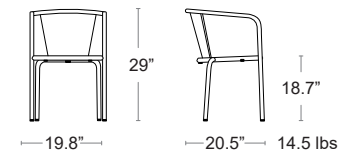

# ARMCHAIRS



## Net

Uniformly colored fiberglass polypropylene with UV additives  
Matte finish, Non-slip feet, Recyclable,  
See in stock cushions, Page 26

**LIST: \$180 EA.    SELL: \$120 EA.**

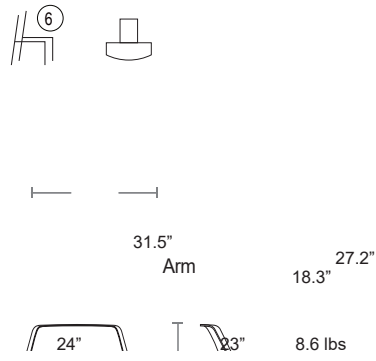

-  BIANCO  
\*A-NAR-40326.00
-  ANTRACITE  
\*A-NAR-40326.02
-  SALICE  
\*A-NAR-40326.04
-  TORTORA  
\*A-NAR-40326.10
-  SENAPE  
\*A-NAR-40326.56
-  CORALLO  
\*A-NAR-40326.75

# ARMCHAIRS









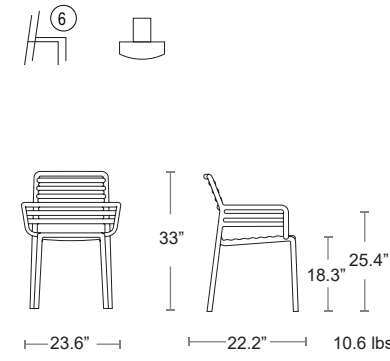

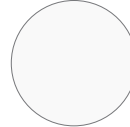
## Doga

Uniformly colored fiberglass and polypropylene with UV additives  
Matte finish, Non-slip feet, Recyclable  
See in stock cushions, Page 26

**LIST: \$180 EA.    SELL: \$120 EA.**



-  BIANCO  
\*A-NAR-40254.00
-  ANTRACITE  
\*A-NAR-40254.02
-  AGAVE  
\*A-NAR-40254.16
-  PERA  
\*A-NAR-40254.18
-  MARSALA  
\*A-NAR-40254.21
- 
-  CAPPUCINO  
\*A-NAR-40254.14
-  MENTA  
\*A-NAR-40254.15
-  TABACCO  
\*A-NAR-40254.53

# ARMCHAIRS

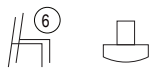



## Tiberina

Uniformly colored fiberglass polypropylene with UV additives  
Matte finish, Non-slip feet, Recyclable

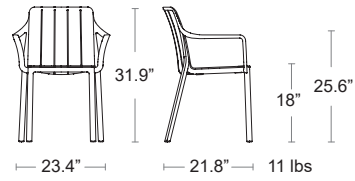
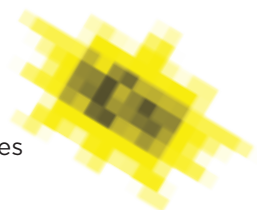
LIST: \$180 EA.    SELL: \$120 EA.

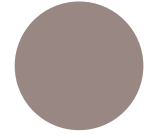

-  ANTRACITE  
\*A-NAR-40205.02
-  TORTORA  
\*A-NAR-40205.10
-  CORDA  
\*A-NAR-40205.24
-  TERRA  
\*A-NAR-40205.44



# ARMCHAIRS

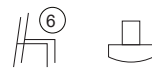





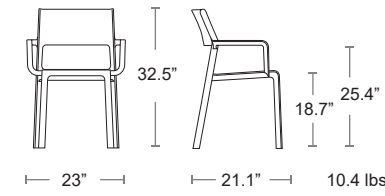

## Trill

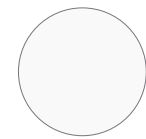
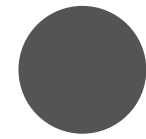
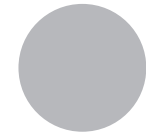
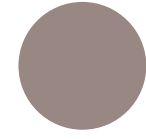
Uniformly colored fiberglass and polypropylene with UV additives  
Matte finish, Non-slip feet, Recyclable  
See in stock cushions, Page 26

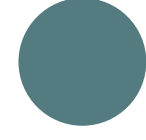
LIST: \$180 EA.    SELL: \$120 EA.



-  BIANCO  
\*A-NAR-40250.00
-  ANTRACITE  
\*A-NAR-40250.02
-  GRIGIO  
\*A-NAR-40250.03
-  TORTORA  
\*A-NAR-40250.10
-  AGAVE  
\*A-NAR-40250.16
-  OTTANIO  
\*A-NAR-40250.49
-  SENAPE  
\*A-NAR-40250.56
-  ROSA BOUQUET  
\*A-NAR-40250.08
-  TABACCO  
\*A-NAR-40250.53



# ARMCHAIRS



## Luna

Uniformly colored fiberglass and polypropylene, Matte finish, Polycarbonate and Resin back, with UV additives, Non-slip feet, Recyclable

LIST: \$170 EA.    SELL: \$110 EA.

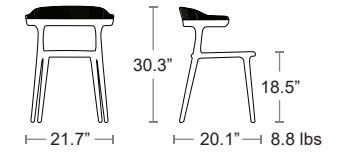

WHITE / CLEAR  
\*A-PPY-LUNA-01-37



ANTRACITE / SMOKE  
\*A-PPY-LUNA-22-38



# ARMCHAIRS



## Mambo

Uniformly colored fiberglass and polypropylene with UV additives, Matte finish, Non-slip feet, Recyclable

LIST: \$170 EA.    SELL: \$110 EA.

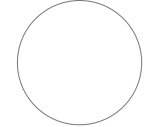
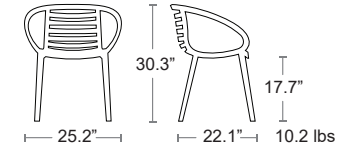

WHITE  
\*A-PPY-MAMBO-01



ANTRACITE  
\*A-PPY-MAMBO-22



# ARMCHAIRS

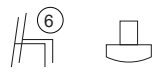



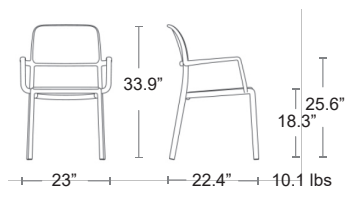

## Riva

Uniformly colored fiberglass and polypropylene with UV additives  
Matte finish, Solid seat and back, Non-slip feet, Recyclable,  
See in stock cushions Page 26

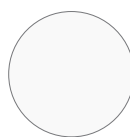
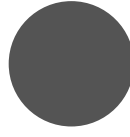
**LIST: \$160 EA.    SELL: \$105 EA.**

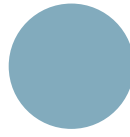

-  BIANCO  
\*A-NAR-40246.00
-  ANTRACITE  
\*A-NAR-40246.02
-  ROSSO  
\*A-NAR-40246.07
-  TORTORA  
\*A-NAR-40246.10
-  AGAVE  
\*A-NAR-40246.16
-  CELESTE  
\*A-NAR-40246.39



# ARMCHAIRS

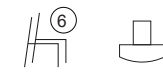



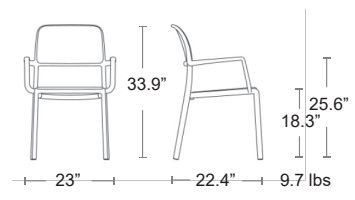

## Bora

Uniformly colored fiberglass and polypropylene with UV additives,  
Matte finish, Solid seat and back, Non-slip feet, Recyclable,  
See in stock cushions Page 26

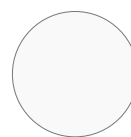
**LIST: \$160 EA.    SELL: \$105 EA.**

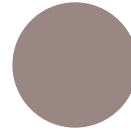

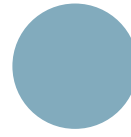
-  BIANCO  
\*A-NAR-40242.00
-  ANTRACITE  
\*A-NAR-40242.02
-  ROSSO  
\*A-NAR-40242.07
-  TORTORA  
\*A-NAR-40242.10
-  AGAVE  
\*A-NAR-40242.16
-  CELESTE  
\*A-NAR-40242.39



# ARMCHAIRS





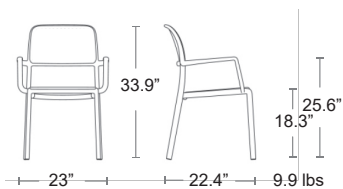

## Costa

Uniformly colored fiberglass and polypropylene with UV additives  
Matte finish, Solid seat and back, Non-slip feet, Recyclable,  
See in stock cushions Page 26

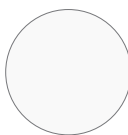
**LIST: \$160 EA.    SELL: \$105 EA.**



-  BIANCO  
\*A-NAR-40244.00
-  ANTRACITE  
\*A-NAR-40244.02
-  ROSSO  
\*A-NAR-40244.07
-  TORTORA  
\*A-NAR-40244.10
-  AGAVE  
\*A-NAR-40244.16
-  CELESTE  
\*A-NAR-40244.39



# ARMCHAIRS



Made in North America, Sunbrella 100% Solution dyed acrylic, Zippered removable cover, washable, Custom Sunbrella Colors available for a 25% Surcharge

**LIST: \$70 EA.    SELL: \$45 EA.**



## Armchair Cushions

### Armchair Cushion

Fits Trill, Riva, Bora, Costa, With ties

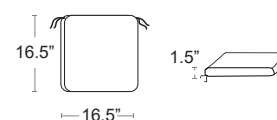
\*C-BUM-GENERIC + COLOR CODE

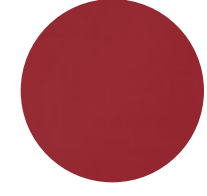
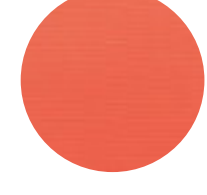
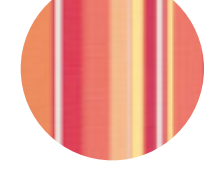

-  SPECTRUM EGGSHELL  
-48018
-  SPECTRUM CHERRY  
-48096
-  CANVAS MELON  
-5415
-  DOLCE MANGO  
-56000
-  MILANO CHAR  
-56079

### Net Cushion

No ties

\*C-BUM-NET-RELAX + COLOR CODE

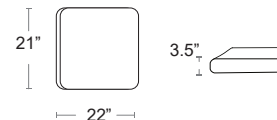

-  SPECTRUM DAFFODIL  
-48024
-  CANVAS GRANITE  
-5402
-  CANVAS ARUBA  
-5416
-  DOLCE OASIS  
-56001
-  CABANA REGATTA  
-58029

### Doga Cushion

Velcro ties

\*C-BUM-DOGA-RELAX + COLOR CODE

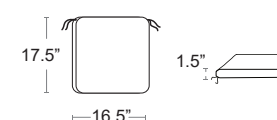

-  SPECTRUM CARBON  
-48085
-  CANVAS REGATTA  
-5493
-  CANVAS PALM  
-5421
-  PEYTON GRANITE  
-56075
-  CABANA CLASSIC  
-58030



### Custom Cushions & Special Orders

We can make cushions for all the chairs and stools we sell in available Sunbrella Fabric  
We have swatches and samples of Special Order colors and fabrics.  
Contact BUM for samples and pricing [samplerrequest@bumoutdoor.ca](mailto:samplerrequest@bumoutdoor.ca)

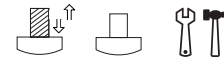

Rio Bench ALU

Aluminum frame and seat, E-Plated Powder Coat finish, Adjustable height feet

LIST: \$710 EA.    SELL: \$465 EA.

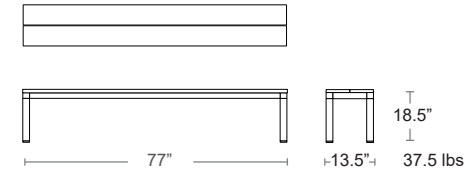

-  RIO BENCH ALU BIANCO  
\*S-NAR-49053.00
-  RIO BENCH ALU ANTRACITE  
\*S-NAR-49052.02
-  RIO BENCH ALU TORTORA  
\*S-NAR-49059.10

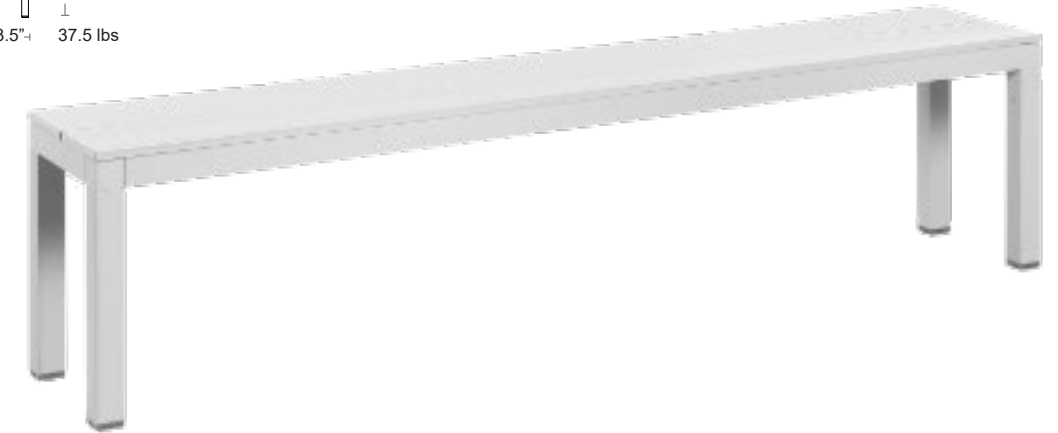

# SIDE CHAIRS

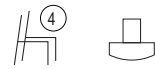

## Marco Polywood Bench

Square tubular aluminum frame, E-Plated Powder Coat finish, Polywood Seat & Back

**LIST: \$620 EA.    SELL: \$405 EA.**

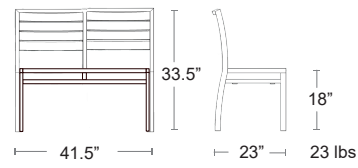

- ANTRACITE/TEAK  
\*S-MARCO-BES-516-TA
- ANTRACITE/GREY  
\*S-MARCO-BES-516-GA
- SILVER/GREY  
\*S-MARCO-BES-516-GS
- SILVER/TEAK  
\*S-MARCO-BES-516-TS



Connecting hardware included with orders of 2 or more

# SIDE CHAIRS



## Marco Sling

Square tubular aluminum frame, E-Plated Powder Coat finish, Batyline Seat & Back

**LIST: \$370 EA.    SELL: \$240 EA.**

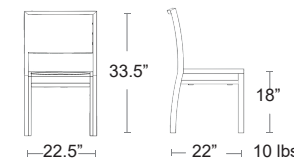

- BATYLINE - SEAT & BACK  
FRAME - SILVER  
\*S-MARCO-516S-BT-GS
- BATYLINE - SEAT & BACK  
FRAME - BLACK  
\*S-MARCO-516S-BT-GA





# SIDE CHAIRS

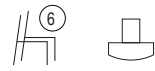

## Marco Polywood

Square tubular aluminum frame, E-Plated Powder Coat finish, Polywood Seat & Back

LIST: \$370 EA.    SELL: \$240 EA.

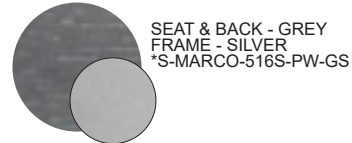
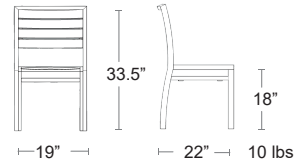

# SIDE CHAIRS



## Marco Wicker

Square tubular aluminum frame, E-Plated Powder Coat finish, Viro Wicker Seat & Back

LIST: \$370 EA.    SELL: \$240 EA.

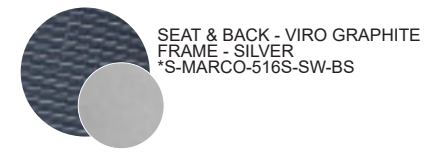
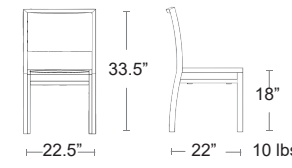

# SIDE CHAIRS



## Parisian

All-welded Aluminum frame, wood-look E-Plated Powder Coat finish with all weather wicker seat and back, replaceable feet.

LIST: \$330 EA.    SELL: \$215 EA.

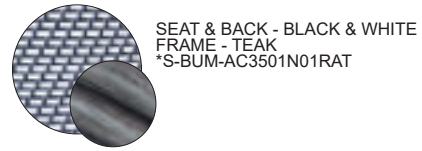
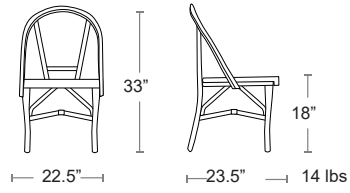
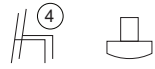

SEAT & BACK - BLACK & WHITE  
 FRAME - TEAK  
 \*S-BUM-AC3501N01RAT



# SIDE CHAIRS



## Adico #786A

Tubular steel frame, Solid steel seat and back E-plated Powder Coat finish

LIST: \$320 EA.    SELL: \$210 EA.

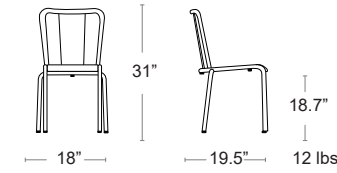

-  YELLOW  
\*S-ADC-786A-1002
-  WHITE  
\*S-ADC-786A-1310
-  ORANGE  
\*S-ADC-786A-2012
-  RED  
\*S-ADC-786A-3169
-  GREEN  
\*S-ADC-786A-6021
-  BLUE  
\*S-ADC-786A-6034
-  BLACK  
\*S-ADC-786A-9005



# SIDE CHAIRS

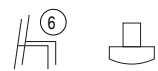



## Tiberina

Uniformly colored fiberglass and polypropylene with UV additives, Matte finish, Non-slip feet, Recyclable resin.

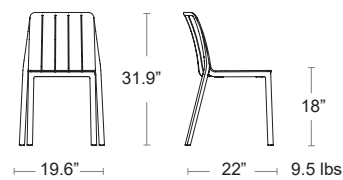
LIST: \$160 EA.    SELL: \$105 EA.

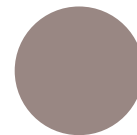

-  ANTRACITE  
\*S-NAR-40206.02
-  TORTORA  
\*S-NAR-40206.10
-  CORDA  
\*S-NAR-40206.24
-  TERRA  
\*S-NAR-40206.44



# SIDE CHAIRS

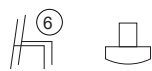



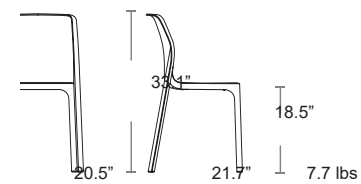

## Bit

Uniformly colored fiberglass and polypropylene with UV additives, Matte finish, Non-slip feet, Recyclable resin

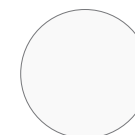
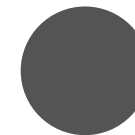
LIST: \$160 EA.    SELL: \$105 EA.

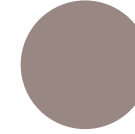

-  BIANCO  
\*S-NAR-40328.00
-  ANTRACITE  
\*S-NAR-40328.02
-  SALICE  
\*S-NAR-40328.04
-  TORTORA  
\*S-NAR-40328.10
-  SENAPE  
\*S-NAR-40328.56
-  CORALLO  
\*S-NAR-40328.75



# SIDE CHAIRS

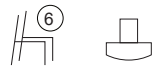







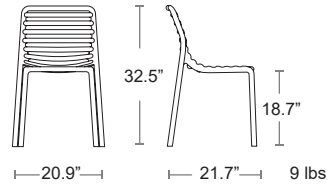

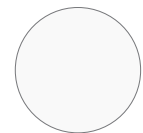
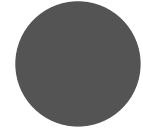
## Doga

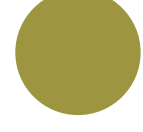
Uniformly colored fiberglass and polypropylene with UV additives, Matte finish, Non-slip feet, Recyclable

LIST: \$160 EA.    SELL: \$105 EA.



-  BIANCO  
\*S-NAR-40255.00
-  ANTRACITE  
\*S-NAR-40255.02
-  AGAVE  
\*S-NAR-40255.16
-  PERA  
\*S-NAR-40255.18
-  MARSALA  
\*S-NAR-40255.21
- 
-  CAPPUCINO  
\*S-NAR-40255.14
-  MENTA  
\*S-NAR-40255.15
-  TABACCO  
\*S-NAR-40255.53



# SIDE CHAIRS

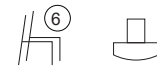







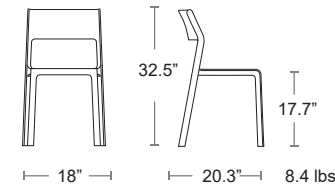

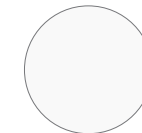

## Trill

Uniformly colored fiberglass and polypropylene with UV additives, Matte finish, Non-slip feet, Recyclable  
See in stock cushions, Page 44

LIST: \$160 EA.    SELL: \$105 EA.



-  BIANCO  
\*S-NAR-40253.00
-  ANTRACITE  
\*S-NAR-40253.02
-  GRIGIO  
\*S-NAR-40253.03
-  TORTORA  
\*S-NAR-40253.10
-  AGAVE  
\*S-NAR-40253.16
-  OTTANIO  
\*S-NAR-40253.49
-  SENAPE  
\*S-NAR-40253.56
- 
-  ROSA BOUQUET  
\*S-NAR-40253.08
-  TABACCO  
\*S-NAR-40253.53



# SIDE CHAIRS

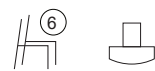

## Varia

Stackable monobloc chair made of fiberglass reinforced polypropylene. With its simple clean lines it is suitable for all commercial applications. Anti UV stabilized.

**LIST: \$150 EA.    SELL: \$100 EA.**

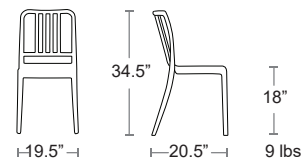

-  WHITE  
\*S-PPY-VARIA-01WHITE
-  RED  
\*S-PPY-VARIA-04RED
-  WARM GREY  
\*S-PPY-VARIA-17WARM GREY
-  ANTRACITE  
\*S-PPY-VARIA-22ANTRACITE



# SIDE CHAIRS

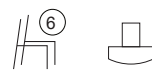



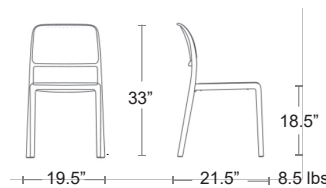

## Riva

Uniformly colored fiberglass and polypropylene with UV additives, Matte finish, Non-slip feet, Recyclable  
See in stock cushions, Page 44

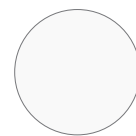
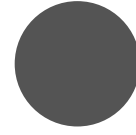
**LIST: \$140 EA.    SELL: \$90 EA.**



-  BIANCO  
\*S-NAR-40247.00
-  ANTRACITE  
\*S-NAR-40247.02
-  ROSSO  
\*S-NAR-40247.07
-  TORTORA  
\*S-NAR-40247.10
-  AGAVE  
\*S-NAR-40247.16
-  CELESTE  
\*S-NAR-40247.39



# SIDE CHAIRS

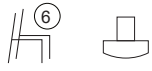



## Bora

Uniformly colored fiberglass and polypropylene with UV additives, Matte finish, Non-slip feet, Recyclable  
See in stock cushions, Page 44

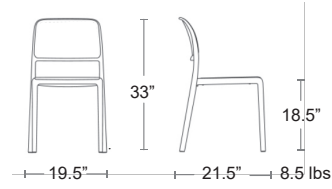
**LIST: \$140 EA.    SELL: \$90 EA.**

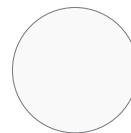
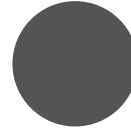
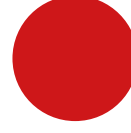
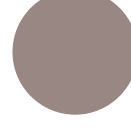

-  BIANCO  
\*S-NAR-40243.00
-  ANTRACITE  
\*S-NAR-40243.02
-  ROSSO  
\*S-NAR-40243.07
-  TORTORA  
\*S-NAR-40243.10
-  AGAVE  
\*S-NAR-40243.16
-  CELESTE  
\*S-NAR-40243.39



# SIDE CHAIRS







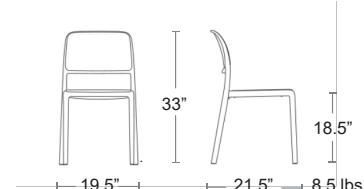

## Costa

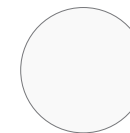
Uniformly colored fiberglass and polypropylene with UV additives, Matte finish, Non-slip feet, Recyclable  
See in stock cushions, Page 44

**LIST: \$140 EA.    SELL: \$90 EA.**

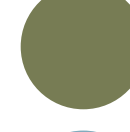

-  BIANCO  
\*S-NAR-40245.00
-  ANTRACITE  
\*S-NAR-40245.02
-  ROSSO  
\*S-NAR-40245.07
-  TORTORA  
\*S-NAR-40245.10
-  AGAVE  
\*S-NAR-40245.16
-  CELESTE  
\*S-NAR-40245.39



# SIDE CHAIRS

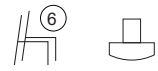



## Stack Mini Stool

Monobloc stool, Uniformly colored fiberglass polypropylene resins with UV additives, Matte finish, Non-slip feet, Recyclable

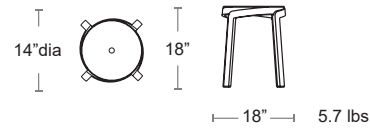
**LIST: \$120 EA.    SELL: \$80 EA.**

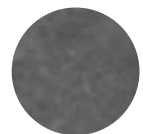
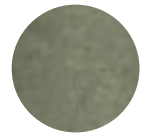
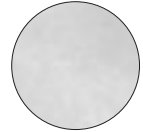

-  **BASALTO**  
\*S-NAR-40357.25
-  **CACTUS**  
\*S-NAR-40357.27
-  **GESSO**  
\*S-NAR-40357.29
-  **TERRA**  
\*S-NAR-40357.44



# SIDE CHAIRS

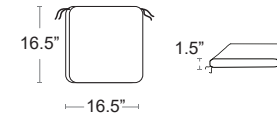









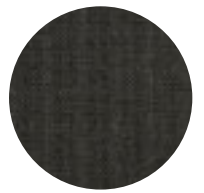
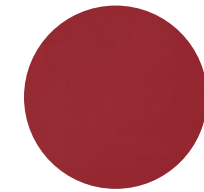

## Side Chair Cushions

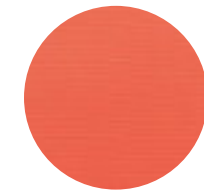
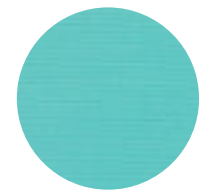
Fits Trill, Riva, Bora, Costa, Side Chairs  
Zippered removable cover, washable, with ties

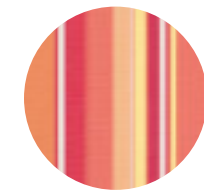
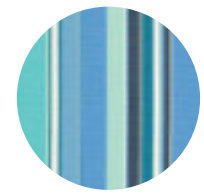
\*C-BUM-GENERIC + COLOR CODE

**LIST: \$70 EA.    SELL: \$45 EA.**

- |  |  |   |
|--|--|---|
|  <b>SPECTRUM EGGSHELL</b><br>-48018 |  <b>SPECTRUM DAFFODIL</b><br>-48024 |  <b>SPECTRUM CARBON</b><br>-48085  |
|  <b>SPECTRUM CHERRY</b><br>-48096   |  <b>CANVAS GRANITE</b><br>-5402     |  <b>CANVAS REGATTA</b><br>-5493    |
|  <b>CANVAS MELON</b><br>-5415      |  <b>CANVAS ARUBA</b><br>-5416      |  <b>CANVAS PALM</b><br>-5421      |
|  <b>DOLCE MANGO</b><br>-56000     |  <b>DOLCE OASIS</b><br>-56001     |  <b>PEYTON GRANITE</b><br>-56075 |
|  <b>MILANO CHAR</b><br>-56079     |  <b>CABANA REGATTA</b><br>-58029  |  <b>CABANA CLASSIC</b><br>-58030 |

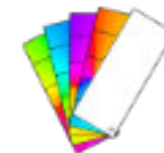

### Custom Cushions & Special Orders

We can make cushions for all the chairs and stools we sell in available Sunbrella Fabric

We have swatches and samples of Special Order colors and fabrics.

Contact BUM for samples and pricing [samplerequest@bumoutdoor.ca](mailto:samplerequest@bumoutdoor.ca)

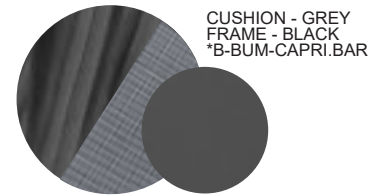
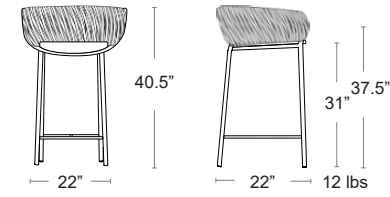

CUSHION - GREY  
FRAME - BLACK  
\*B-BUM-CAPRI.BAR

Capri

Black All Weather Rope back & arms. Antracite round tubular aluminum frame, E-Plated Powder Coat finish, Textaline seat cushion, Replaceable feet

LIST: \$510 EA.    SELL: \$335 EA.

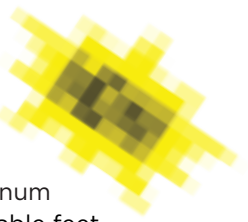



# BAR STOOLS



39"  
30"  
21.5" 22" 13 lbs



## ReCLIPS

Stackable stools with plastic slats made from 97% recycled polypropylene + color pigments + UV protection, clipped on an aluminum frame, E-Plated Powder Coat finish

LIST: \$500 EA. SELL: **\$325 EA.**



# BAR STOOLS

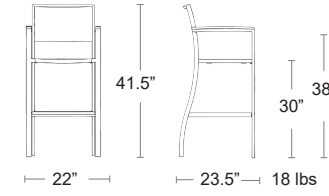

## Marco Sling Bar - Arm

Square tubular aluminum frame, E-Plated Powder Coat finish, Batyline Seat & Back, Polywood Armrests

LIST: \$480 EA. SELL: **\$315 EA.**



# BAR STOOLS



## Marco Polywood Bar - Arm

Square tubular aluminum frame, E-Plated Powder Coat finish, Polywood Seat, Back & Armrests

LIST: \$480 EA.    SELL: **\$315 EA.**

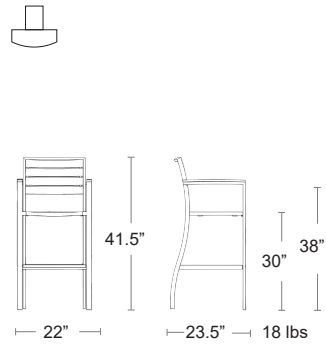

SEAT & BACK - TEAK  
FRAME - ANTRACITE  
\*B-MARCO-516B-PW-TA



SEAT & BACK - GREY  
FRAME - ANTRACITE  
\*B-MARCO-516B-PW-GA

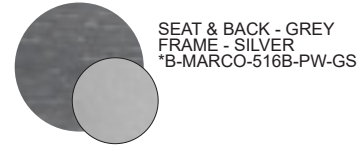

SEAT & BACK - GREY  
FRAME - SILVER  
\*B-MARCO-516B-PW-GS



SEAT & BACK - TEAK  
FRAME - SILVER  
\*B-MARCO-516B-PW-TS



# BAR STOOLS



## Marco Wicker - Arm

Square tubular aluminum frame, E-Plated Powder Coat finish, Viro Wicker Seat & Back, Polywood Armrests

LIST: \$480 EA.    SELL: **\$315 EA.**

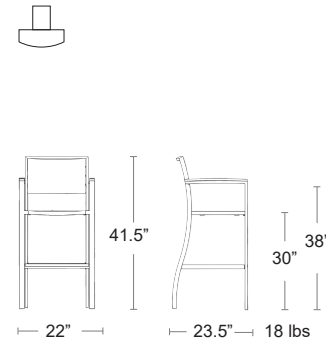

SEAT & BACK - VIRO GRAPHITE  
FRAME - SILVER  
\*B-MARCO-516B-SW-BS

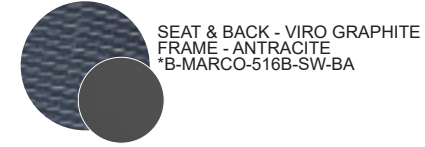

SEAT & BACK - VIRO GRAPHITE  
FRAME - ANTRACITE  
\*B-MARCO-516B-SW-BA



# BAR STOOLS

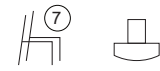

## Parisian

All-welded Aluminum frame, wood-look E-Plated Powder Coat finish, with all weather wicker seat and back, replaceable feet.

LIST: \$460 EA.    SELL: **\$300 EA.**

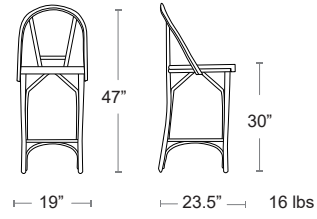

# BAR STOOLS



## Marco Sling Bar - Armless

Square tubular aluminum frame, E-Plated Powder Coat finish, Batyline Seat & Back

LIST: \$420 EA.    SELL: **\$275 EA.**

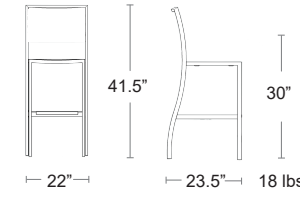

# BAR STOOLS

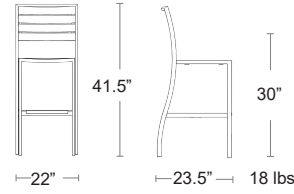

## Polywood Bar - Armless

Square tubular aluminum frame, E-Plated Powder Coat finish, Polywood Seat & Back

LIST: \$420 EA.    SELL: \$275 EA.



SEAT & BACK - TEAK  
FRAME - ANTRACITE  
\*B-MARCO-517B-PW-TA



SEAT & BACK - GREY  
FRAME - ANTRACITE  
\*B-MARCO-517B-PW-GA

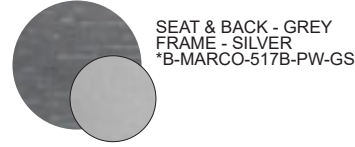

SEAT & BACK - GREY  
FRAME - SILVER  
\*B-MARCO-517B-PW-GS



SEAT & BACK - TEAK  
FRAME - SILVER  
\*B-MARCO-517B-PW-TS



# BAR STOOLS

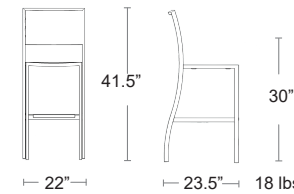

## Marco Wicker - Armless

Square tubular aluminum frame, E-Plated Powder Coat finish, Viro Wicker Seat & Back

LIST: \$420 EA.    SELL: \$275 EA.

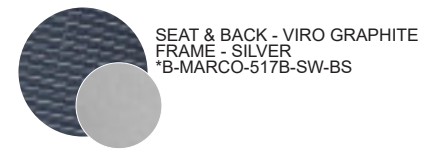

SEAT & BACK - VIRO GRAPHITE  
FRAME - SILVER  
\*B-MARCO-517B-SW-BS

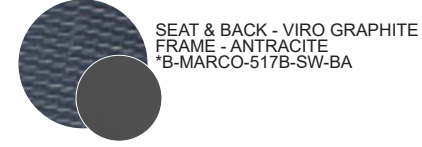

SEAT & BACK - VIRO GRAPHITE  
FRAME - ANTRACITE  
\*B-MARCO-517B-SW-BA





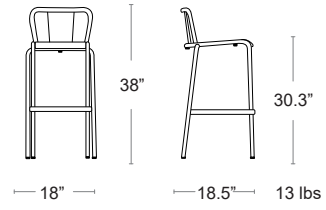
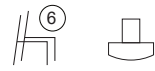



# BAR STOOLS

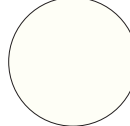

## Adico 786B

Tubular steel frame, Solid steel seat and back E-plated Powder Coat finish

LIST: \$400 EA.    SELL: \$260 EA.

-  YELLOW  
\*B-ADC-786B-1002
-  WHITE  
\*B-ADC-786B-1310
-  ORANGE  
\*B-ADC-786B-2012
-  RED  
\*B-ADC-786B-3169
-  GREEN  
\*B-ADC-786B-6021
-  BLUE  
\*B-ADC-786B-6034
-  BLACK  
\*B-ADC-786B-9005





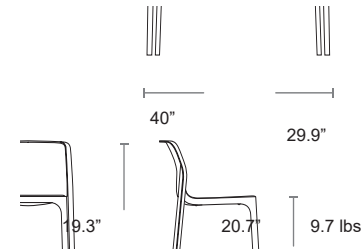



# BAR STOOLS



## Net Bar

Uniformly colored fiberglass and polypropylene with UV additives, Matte finish, Non-slip feet, Recyclable.

LIST: \$200 EA.    SELL: \$130 EA.

-  BIANCO  
\*B-NAR-40355.00
-  ANTRACITE  
\*B-NAR-40355.02
-  SALICE  
\*B-NAR-40355.04
-  TORTORA  
\*B-NAR-40355.10
-  SENAPE  
\*B-NAR-40355.56
-  CORALLO  
\*B-NAR-40355.75



# BAR STOOLS

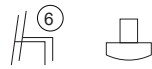





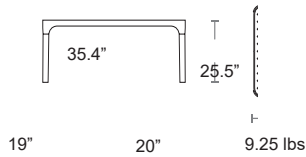

## Net Counter

Uniformly colored fiberglass and polypropylene with UV additives, Matte finish, Non-slip feet, Recyclable.

**LIST: \$200 EA**    **SELL: \$130 EA**



-  BIANCO  
\*B-NAR-40356.00
-  ANTRACITE  
\*B-NAR-40356.02
-  SALICE  
\*B-NAR-40356.04
-  TORTORA  
\*B-NAR-40356.10
-  SENAPE  
\*B-NAR-40356.56
-  CORALLO  
\*B-NAR-40356.75

# BAR STOOLS









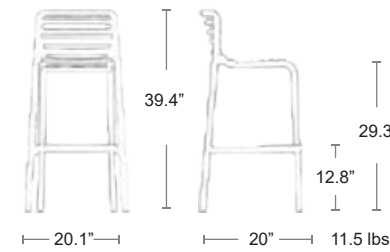

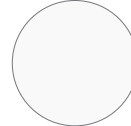
## Doga Bar

Uniformly colored fiberglass and polypropylene with UV additives, Matte finish, Non-slip feet, Recyclable

**LIST: \$200 EA.**    **SELL: \$130 EA.**



-  BIANCO  
\*B-NAR-40348.00
-  ANTRACITE  
\*B-NAR-40348.02
-  AGAVE  
\*B-NAR-40348.16
-  PERA  
\*B-NAR-40348.18
-  MARSALA  
\*B-NAR-40348.21
- 
-  CAPPUCINO  
\*B-NAR-40348.14
-  MENTA  
\*B-NAR-40348.15
-  TABACCO  
\*B-NAR-40348.53

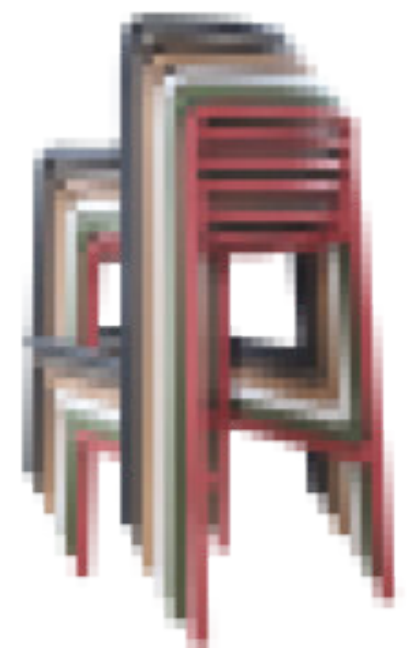

# BAR STOOLS

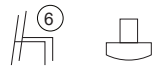

## Trill Bar

Uniformly colored fiberglass and polypropylene with UV additives, Matte finish, Non-slip feet, Recyclable resin

**LIST: \$200 EA.    SELL: \$130 EA.**

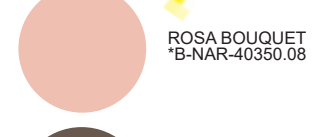
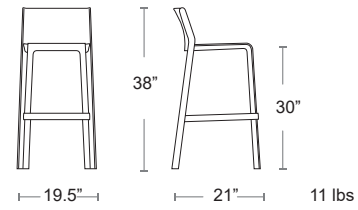

# BAR STOOLS



## Trill Counter

Uniformly colored fiberglass and polypropylene with UV additives, Matte finish, Non-slip feet, Recyclable resin

**LIST: \$200 EA    SELL: \$130 EA**

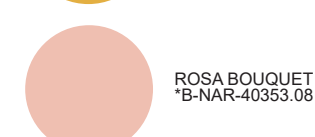
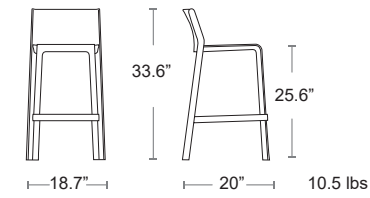

# BAR STOOLS

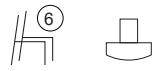

## Lido Bar

Uniformly colored fiberglass and polypropylene with UV additives, Perforated seat and back, Matte finish, Non-slip feet, Recyclable

**LIST: \$180 EA.    SELL: \$120 EA.**

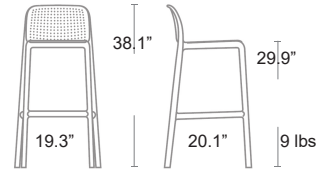

BIANCO  
\*B-NAR-40344.00



ANTRACITE  
\*B-NAR-40344.02



ROSSO  
\*B-NAR-40344.07



TORTORA  
\*AB-NAR-40344.10



AGAVE  
\*B-NAR-40344.16



CELESTE  
\*B-NAR-40344.39



# BAR STOOLS

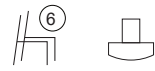

## Lido Counter

Uniformly colored fiberglass and polypropylene with UV additives, Perforated seat and back, Matte finish, Non-slip feet, Recyclable

**LIST: \$180 EA.    SELL: \$120 EA.**

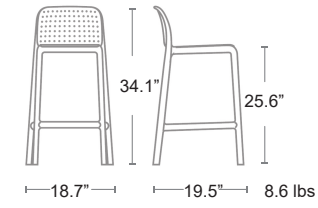

ANTRACITE  
\*B-NAR-40345.02





# BAR STOOLS

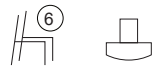





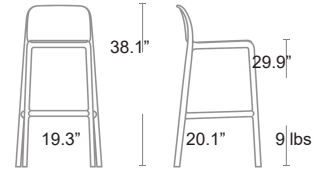

## Faro Bar

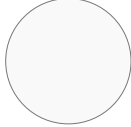
Uniformly colored fiberglass and polypropylene with UV additives, Solid seat and back, Matte finish, Non-slip feet, Recyclable

**LIST: \$180 EA.    SELL: \$120 EA.**



-  BIANCO  
\*B-NAR-40346.00
-  ANTRACITE  
\*B-NAR-40346.02
-  ROSSO  
\*B-NAR-40346.07
-  TORTORA  
\*B-NAR-40346.10
-  AGAVE  
\*B-NAR-40346.16
-  CELESTE  
\*B-NAR-40346.39



# BAR STOOLS

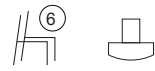

## Faro Counter

Uniformly colored fiberglass and polypropylene with UV additives, Solid seat and back, Matte finish, Non-slip feet, Recyclable

**LIST: \$180 EA.    SELL: \$120 EA.**

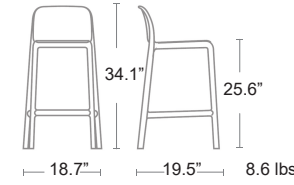

-  ANTRACITE  
\*B-NAR-40347.02
-  ROSSO  
\*B-NAR-40347.07



# BAR STOOLS



## Stack Maxi

Monobloc stool. Uniformly colored fiberglass polypropylene resins with UV additives, Matte finish, Non-slip feet, Recyclable

LIST: \$170 EA.    SELL: \$110 EA.

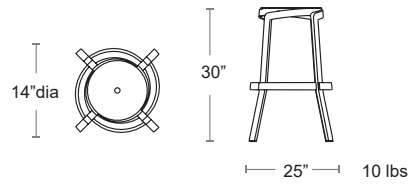
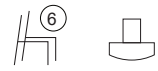

BASALTO  
\*B-NAR-40358.25

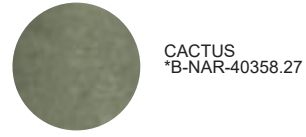

CACTUS  
\*B-NAR-40358.27



GESSO  
\*B-NAR-40358.29



TERRA  
\*B-NAR-40358.44



# TABLES: DINING HEIGHT



## TABLES: DINING HEIGHT



### Marco Polywood Round Cluster Seat

Round tubular steel frame, E-Plated Powder Coat finish, Polywood and Aluminum Seats and Tabletop, Seats 8, Can be bolted down, hardware included

**LIST: \$3100 EA.    SELL: \$2015 EA.**

TOP & SEATS GREY POLYWOOD  
FRAME ANTRACITE  
\*T-BUM-CS-760-PW-GA

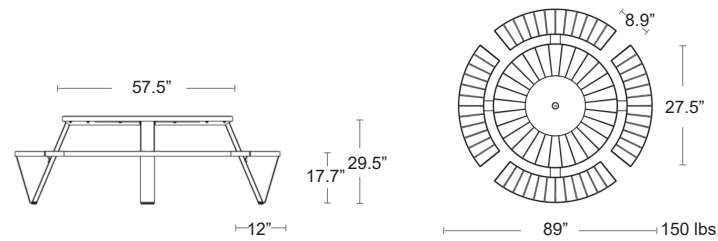
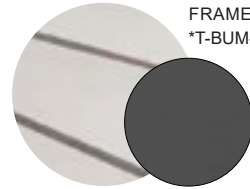

## TABLES: DINING HEIGHT



### Marco Polywood Cluster 4 Seat Table

Round tubular steel frame, E-Plated Powder Coat finish, Polywood and Aluminum Seats and Tabletop, No umbrella base required, Can be bolted down, hardware included

**LIST: \$2530 EA.    SELL: \$1645 EA.**

TOP & SEATS GREY POLYWOOD  
FRAME ANTRACITE  
\*T-BUM-CS-7114-PW-GA

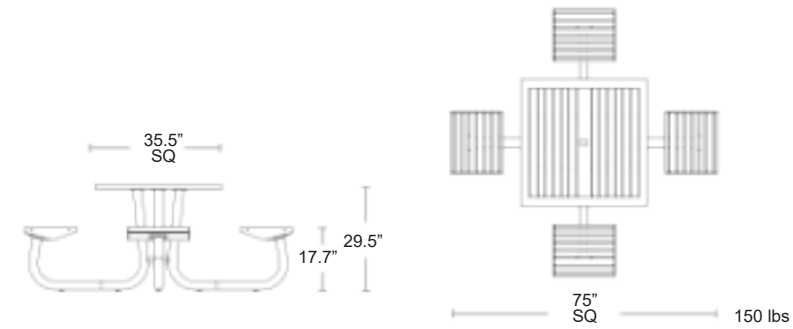
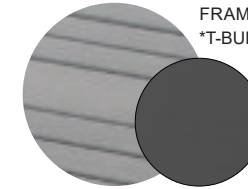

## TABLES: DINING HEIGHT



### Cluster 3 Seat ADA

Round tubular steel frame, E-Plated Powder Coat finish, Polywood and Aluminum Seats and Tabletop, No umbrella base required, Can be bolted down, hardware included

**LIST: \$2430 EA.    SELL: \$1580 EA.**

TOP & SEATS GREY POLYWOOD  
FRAME ANTRACITE  
\*T-BUM-CS-7113-PW-GA-ADA

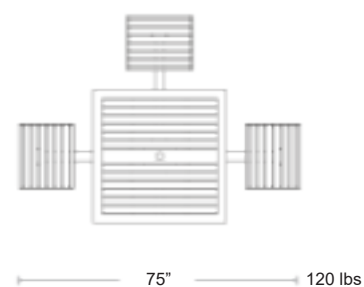
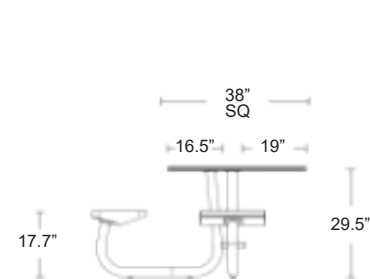
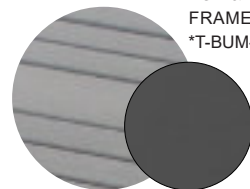

## TABLES: DINING HEIGHT - EXTENDABLE

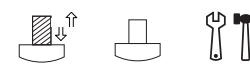

### Rio 210 Aluminum Extendable Table

Tubular aluminum frame and legs, Aluminum top. E-Plated Powder Coat finish. Removable leaf with under table storage, UV Protected, Seats 8-10

**LIST: \$2480 EA.    SELL: \$1615 EA.**

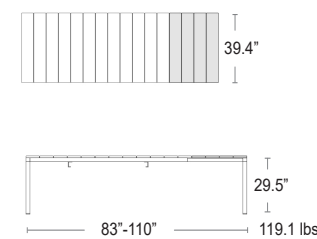

### Panel Replacements

Specify End or Extension & color  
RIO 210 Aluminum  
\*PT-NAR-204883

**LIST: \$490 EA.    SELL: \$245 EA.**

## TABLES: DINING HEIGHT - EXTENDABLE



### Rio 140 Aluminum Extendable Table

Tubular aluminum frame and legs, Aluminum top. E-Plated Powder Coat finish. Removable leaf with under table storage, UV Protected, Seats 6-8

LIST: \$1880 EA.    SELL: \$1220 EA.

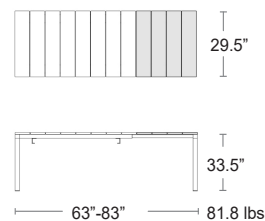
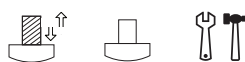

BIANCO  
\*T-NAR-48653.00.000 ALU RIO 140

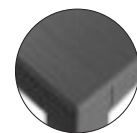

ANTRACITE  
\*T-NAR-48652.02.000 ALU RIO 140

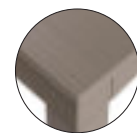

TORTORA  
\*T-NAR-48659.10.000 ALU RIO 140



### Panel Replacements

Specify End or Extension

RIO 140 Aluminum

\*PT-NAR-204863

LIST: \$440 EA.    SELL: \$220 EA.

## TABLES: DINING HEIGHT - EXTENDABLE



### Tevere 210 Extendable Table

Top regenerated uniformly colored fiberglass recyclable polypropylene resins, Frame coated aluminum, Matte finish, Seats 8-10

LIST: \$2180 EA.    SELL: \$1420 EA.

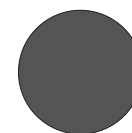
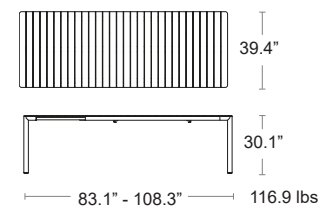
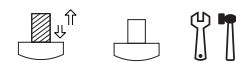

ANTRACITE  
\*T-NAR-49652.02

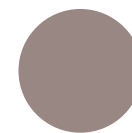

TORTORA  
\*T-NAR-49659.10



CORDA  
\*T-NAR-49669.24



TERRA  
\*T-NAR-49668.44



## TABLES: DINING HEIGHT - EXTENDABLE



### Tevere 147 Extendable Table

Top regenerated uniformly colored fiberglass recyclable polypropylene resins, Frame coated aluminum, Matte finish, Seats 6-8

**LIST: \$1710 EA.    SELL: \$1110 EA.**

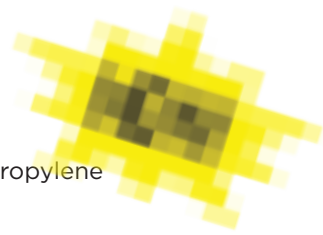
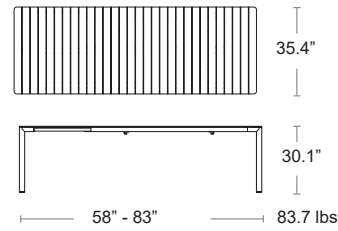

## TABLES: DINING HEIGHT - EXTENDABLE

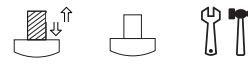

### Rio 210 Resin Extendable Table

Tubular aluminum frame and legs, E-Plated Powder Coat finish, Resin top, Removable leaf with under table storage, UV Protected, Seats 8-10

**LIST: \$1580 EA.    SELL: \$1030 EA.**

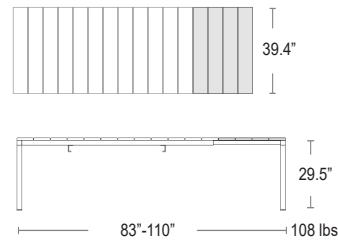

**Panel Replacements**  
Specify End or Extension & Color  
RIO 210 Resin  
\*PT-NAR-204823  
**LIST: \$210 EA.    SELL: \$105 EA.**

## TABLES: DINING HEIGHT - EXTENDABLE



### Rio 140 Resin Extendable Table

Tubular aluminum frame and legs, E-Plated Powder Coat finish, Resin top, Removable leaf with under table storage, UV Protected, Seats 6-8

LIST: \$1300 EA.    SELL: **\$845 EA.**

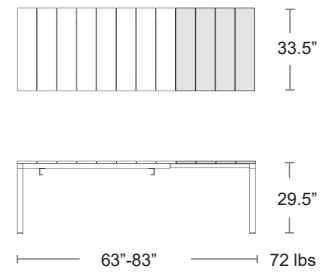
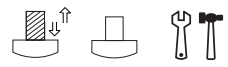

### Panel Replacements

Specify End or Extension

RIO 140 Resin

\*PT-NAR-204833

LIST: \$200 EA.    SELL: **\$100 EA.**

## TABLES: DINING HEIGHT



### Rio Bench ALU

Aluminum frame and seat, E-Plated Powder Coat finish, Adjustable height feet

LIST: \$710 EA.    SELL: **\$465 EA.**

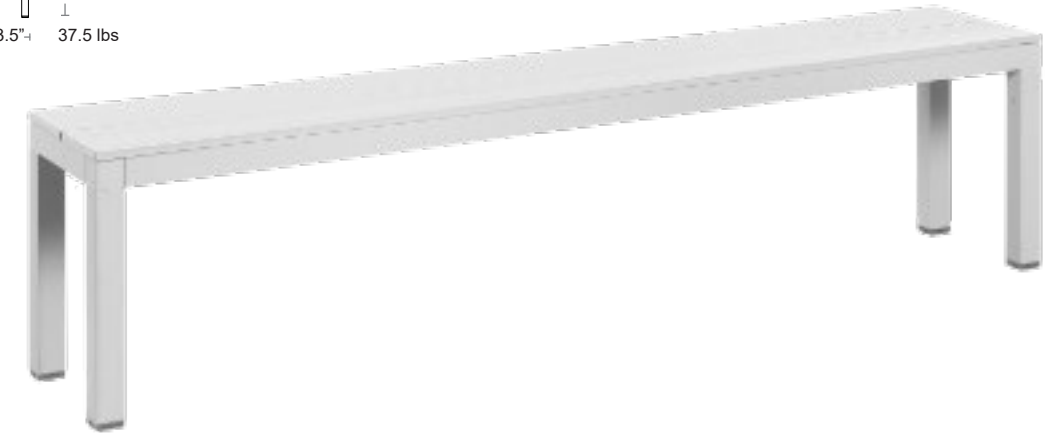
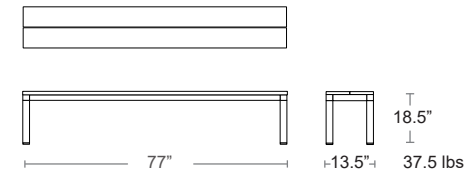
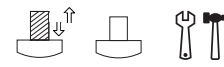

## TABLES: DINING HEIGHT



### Eclipse 87 x 40

Aluminum 5 slat top dining table with umbrella hole and plug,  
All aluminum frame, E-Plated Powder Coat finish

**LIST: \$2820 EA.    SELL: \$1835 EA.**

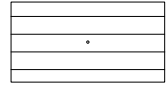

\*T-BUM-EP-4086



## TABLES: DINING HEIGHT



### Adico Tables

Tubular Steel Base, E-Plated Powder Coat Finish, Okoume Marine Plywood Top  
Industrial Clear Outdoor Epoxy, 2 leveler & 2 regular feet

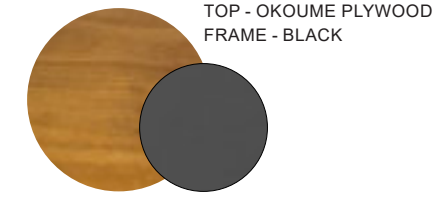
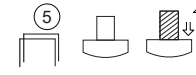

### Adico 55" x 28"

\*T-ADC-5028-140X70RECT

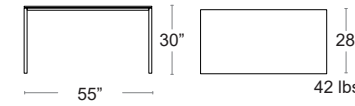

**LIST: \$1240 EA.  
SELL: \$810 EA.**

### Adico 36" Square

\*T-ADC-5028-90SQ

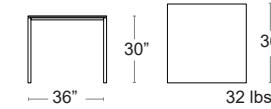

**LIST: \$870 EA.  
SELL: \$565 EA.**

### Adico 28" Square

\*T-ADC-5028-70SQ

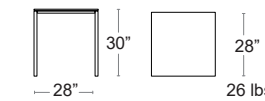

**LIST: \$520 EA.  
SELL: \$340 EA.**





## TABLES: DINING HEIGHT



### Marco Polywood Tables

Square tubular aluminum frame E-Plated Powder Coat finish, Polywood tabletop, An extra slat with the umbrella hole is included for tables with that option.

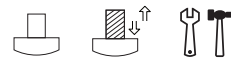

#### Marco 55" x 32"

\*T-MARCO-DT516-55Q + COLOR CODE

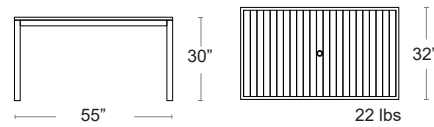

LIST: \$960 EA.  
SELL: \$625 EA.



#### Marco 48" x 32"

\*T-MARCO-DT516-48Q + COLOR CODE

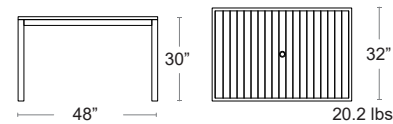

LIST: \$840 EA.  
SELL: \$545 EA.



#### Marco 24" x 32"

\*T-MARCO-DT516-23Q + COLOR CODE

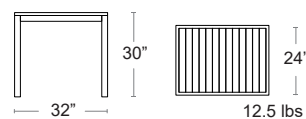

LIST: \$570 EA.  
SELL: \$370 EA.



TOP - TEAK  
FRAME - ANTRACITE



TOP - GREY  
FRAME - ANTRACITE



TOP - GREY  
FRAME - SILVER



TOP - TEAK  
FRAME - SILVER

## TABLES: DINING HEIGHT



### Marco Polywood Tables

Square tubular aluminum frame E-Plated Powder Coat finish, Polywood tabletop, An extra slat with the umbrella hole is included for tables with that option.

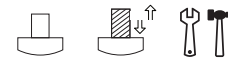

#### Marco 36" Square

\*T-MARCO-DT516-36S + COLOR CODE

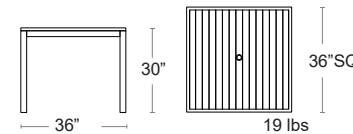

LIST: \$770 EA.  
SELL: \$500 EA.



#### Marco 32" Square

\*T-MARCO-DT516-32S + COLOR CODE

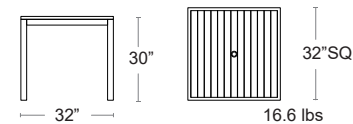

LIST: \$690 EA.  
SELL: \$500 EA.

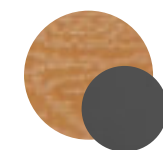

TOP - TEAK  
FRAME - ANTRACITE

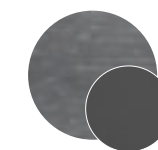

TOP - GREY  
FRAME - ANTRACITE

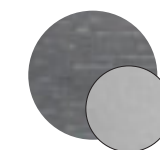

TOP - GREY  
FRAME - SILVER



TOP - TEAK  
FRAME - SILVER

## TABLES: DINING HEIGHT

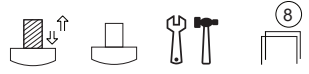

### Cube Tables

Resin and fiberglass slat top, Tubular aluminum legs, E-Plated Powder Coat finish & UV Protected

#### Cube Rectangle

##### Cube 140

\*T-NAR-47752.02

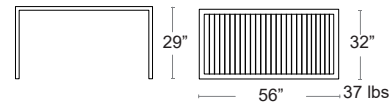

**LIST: \$580 EA.**

**SELL: \$380 EA.**

##### Cube 120

\*T-NAR-47652.02

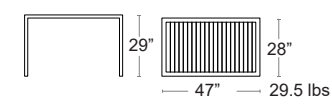

**LIST: \$530 EA.**

**SELL: \$345 EA.**

#### Cube Square

##### Cube 80

\*T-NAR-48052.02

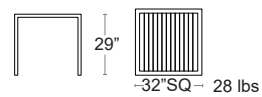

**LIST: \$400 EA.**

**SELL: \$260 EA.**

##### Cube 70

\*T-NAR-47852.02

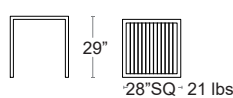

**LIST: \$380 EA.**

**SELL: \$250 EA.**



ANTRACITE  
.02

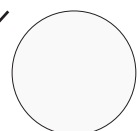
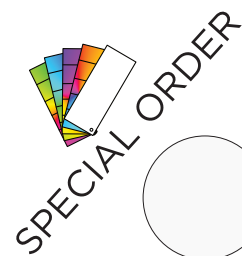

BIANCO  
.00

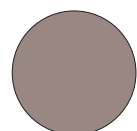

TORTORA  
.10

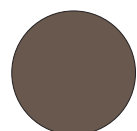

TABACCO  
.53

## TABLES: DINING HEIGHT



### Combo

Table with center column and 4 spokes, Material: regenerated uniformly colored fiberglass polypropylene resins with UV additives, Matte finish, Recyclable resin

#### Combo 70

T-NAR-40032 + COLOR CODE

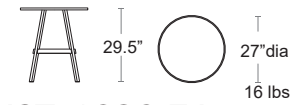

**LIST: \$380 EA.**

**SELL: \$250 EA.**

#### Combo 60

T-NAR-40030 + COLOR CODE

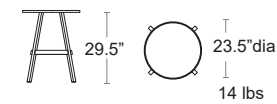

**LIST: \$330 EA.**

**SELL: \$215 EA.**

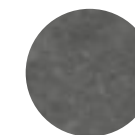

BASALTO  
.25

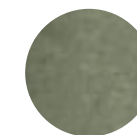

CACTUS  
.27

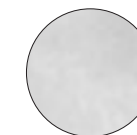

GESSO  
.29



TERRA  
.44

## TABLES: DINING HEIGHT



### Clip Dining

Resin and fiberglass perforated top, Tubular resin and fiberglass legs, UV Protected

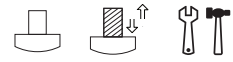

#### Clip 80

\*T-NAR-40082 + COLOR CODE

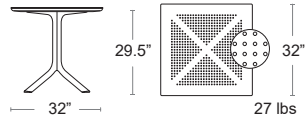

**LIST: \$360 EA.**  
**SELL: \$235 EA.**

#### Clip 70

\*T-NAR-40084 + COLOR CODE

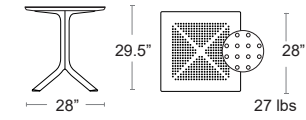

**LIST: \$340 EA.**  
**SELL: \$220 EA.**

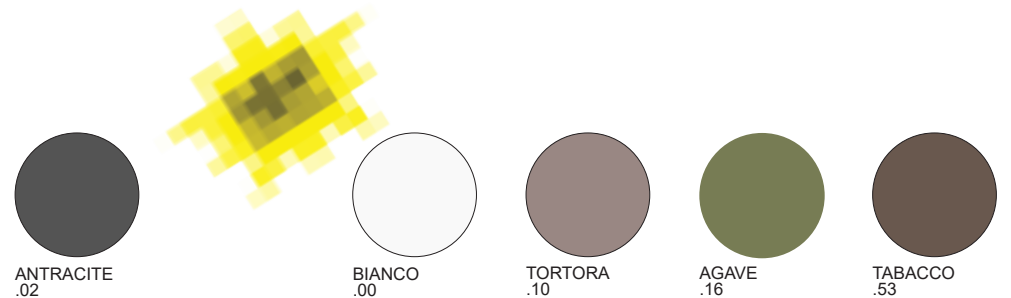

## TABLES: DINING HEIGHT



### Spritz Table Dining & Lounge Height

Solid resin and fiberglass top with center column and three spokes, UV Protected,

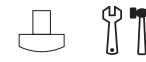

**LIST: \$190 EA.**    **SELL: \$125 EA.**

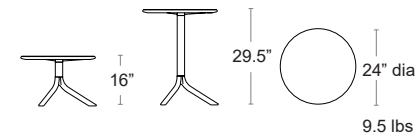

DINING



LOUNGE



Includes removable stems for height variations



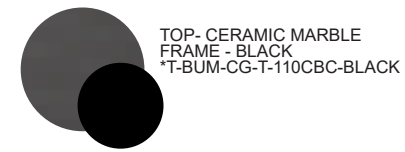
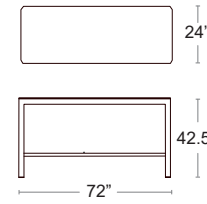

### Stone Ceramic Top Bar Table

All Aluminum Frame, E-Plated Powder Coat Finish  
Ceramic Tabletop Surface

LIST: \$1640 EA.    SELL: \$1065 EA.



## TABLES: BAR HEIGHT



### Stone Ceramic Top Counter Table

All Aluminum Frame, E-Plated Powder Coat Finish  
Ceramic Tabletop Surface

**LIST: \$1630 EA.**    **SELL: \$1060 EA.**

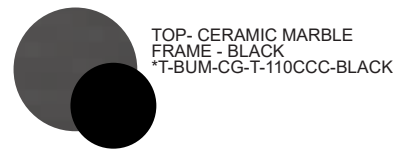
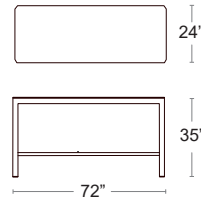

## TABLES: BAR HEIGHT



### Adico Bar Tables

Tubular Steel Base, E-Plated Powder Coat finish, Okoume Marine Plywood Top,  
Industrial Clear Outdoor Epoxy, 2 leveler & 2 regular feet

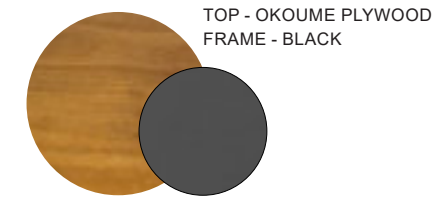

#### Adico 55" x 28"

\*T-ADC-IKA-A-140X70RECT

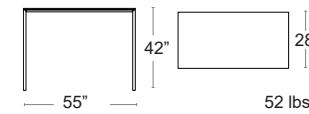

**LIST: \$1460 EA.**  
**SELL: \$950 EA.**

#### Adico 55" x 24"

\*T-ADC-IKA-A-140X60RECT

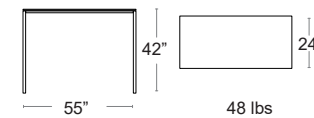

**LIST: \$1340 EA.**  
**SELL: \$870 EA.**

#### Adico 28" Square

\*T-ADC-IKA-A-70SQ

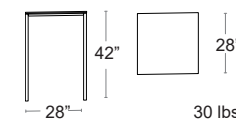

**LIST: \$840 EA.**  
**SELL: \$550 EA.**



## TABLES: BAR HEIGHT

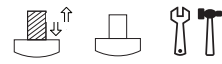

### Cube Tables

Resin and fiberglass slat top, Tubular aluminum legs, E-Plated Powder Coat finish & UV Protected

#### Cube Rectangle



#### Cube 140

\*T-NAR-47752.02+46952.02

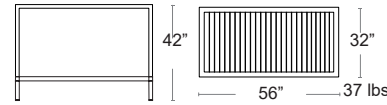

LIST: \$780 EA.

SELL: \$515 EA.

#### Cube 120

\*T-NAR-47652.02+46852.02

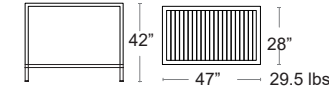

LIST: \$720 EA.

SELL: \$470 EA.

#### Cube Square



#### Cube 80

\*T-NAR-48052.02+ 48152.02

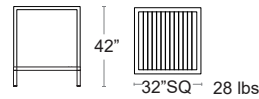

LIST: \$580 EA.

SELL: \$380 EA.

#### Cube 70

\*T-NAR-47852.02+47952.02

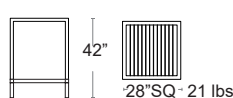

LIST: \$550 EA.

SELL: \$360 EA.



ANTRACITE  
.02

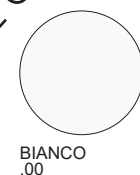

BIANCO  
.00



TORTORA  
.10



TABACCO  
.53

## TABLES: BAR HEIGHT



### Combo Bar

Table with center column and 4 spokes, Material: regenerated uniformly colored fiberglass polypropylene resins with UV additives, Matte finish, Recyclable

#### Combo Bar 70

T-NAR-40032 + 40031 + COLOR CODE

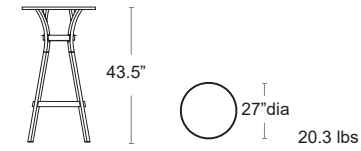

LIST: \$490 EA.

SELL: \$320 EA.

#### Combo Bar 60

7-NAR-40030 + 40031 + COLOR CODE

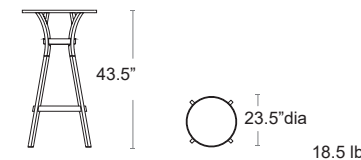

LIST: \$440 EA.

SELL: \$285 EA.



BASALTO  
.25

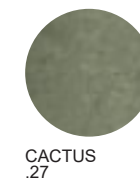

CACTUS  
.27





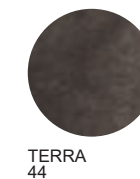



GESSO  
.29



TERRA  
.44



Tabletop & Base Fit Guide

								
		24"x32"	48"x32"	32" Dia	30" Dia	24"	32"	36"
SINGLE DINING HEIGHT	FIORE DINING	★		★	★	★	★	
	FLUTE TILTING			★	★	★		
	FRASCA MAXI			★	★		★	★
	FRASCA MINI	★		★	★	★	★	
	IBISCO TILTING	★		★	★	★	★	
	TRAIL DINING LARGE							★
	TRAIL DINING SMALL	★		★	★	★	★	
	CLIP DINING	★		★	★	★	★	
DOUBLE DINING HEIGHT	SCUDO TILTING		★					
	TRAIL DINING DOUBLE		★					
SINGLE BAR HEIGHT	FIORE BAR	★		★	★	★		
	FRASCA TILTING	★		★	★	★		
	IBISCO TILTING	★		★	★	★		
	TRAIL BAR LARGE						★	★
	TRAIL BAR SMALL	★		★	★	★		
DOUBLE BAR HEIGHT	SCUDO DOUBLE TILTING		★					

**NARDI BASES CAN BE CUT DOWN FOR \$40 NET, SCUDO \$80 NET  
TRAIL BASES CANNOT BE CUT**

BUM COMMERCIAL FURNITURE will provide the necessary hardware if both top and base are purchased on the same Purchase Order.



### Jakarta Teak

Solid Natural Teak 1" Thick  
8 pre-drilled stainless steel inserts to connect to Nardi table bases

	SIZE		WEIGHT	LIST	SELL
MT-TEAK48X32	48"x32"		36 lbs	\$720	<del>\$470</del>
MT-TEAK24X32	24"x32"		17 lbs	\$440	<del>\$290</del>
MT-TEAK30RD	30"		15 lbs	\$400	<del>\$260</del>
MT-TEAK36SQ	36"		30 lbs	\$600	<del>\$390</del>
MT-TEAK32SQ	32"		23 lbs	\$480	<del>\$315</del>
MT-TEAK24SQ	24"		13 lbs	\$350	<del>\$230</del>

Teak will develop a warm gray patina over time or it can be oiled annually to maintain the look of new wood.



### Bum Exteriolit Classic

Poplar veneer marine grade plywood board with 1/16" HPL coating on both sides, 1.2" thick, Moisture resistant, UV protected, Self tapping screws included

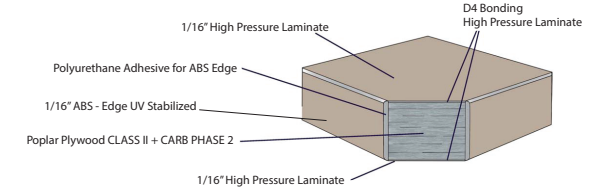

ATRIUM GREY	MARBLE CARRARA	MARBLE PIETRO	SILVER FABRIC	SIZE	WGT.	MSRP	SELL
*TT-SV-AG 48X32	*TT-SV-CM 48X32	*TT-SV-PM 48X32	*TT-SV-SF EX48X32	48"x32"		38 lbs	\$770 <del>\$500</del>
*TT-SV-AG 24X32	*TT-SV-CM 24X32	*TT-SV-PM 24X32	*TT-SV-SF EX24X32	24"x32"		19 lbs	\$390 <del>\$255</del>
*TT-SV-AG 30RD	*TT-SV-CM 30RD	*TT-SV-PM 30RD	*TT-SV-SF EX30RD	30"		20 lbs	\$500 <del>\$325</del>
*TT-SV-AG 36SQ	*TT-SV-CM 36SQ	*TT-SV-PM 36SQ	*TT-SV-SF EX36SQ	36"		32 lbs	\$550 <del>\$360</del>
*TT-SV-AG 32SQ	*TT-SV-CM 32SQ	*TT-SV-PM 32SQ	*TT-SV-SF EX32SQ	32"		25 lbs	\$530 <del>\$345</del>
*TT-SV-AG 24SQ	*TT-SV-CM 24SQ	*TT-SV-PM 24SQ	*TT-SV-SF EX24SQ	24"		14 lbs	\$310 <del>\$205</del>

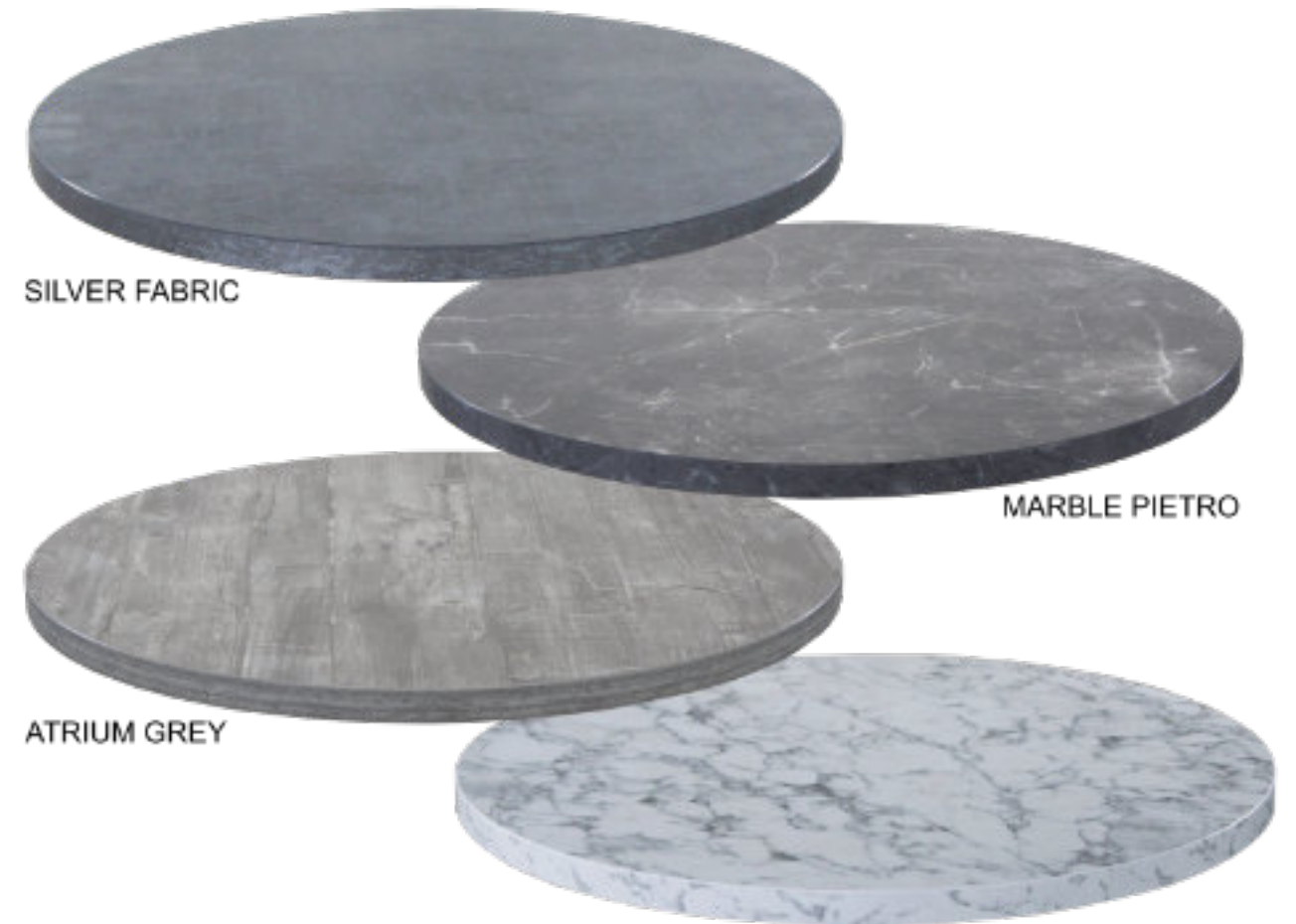

MARBLE CARRARA





Bum Compact HPL

High pressure laminate top, slightly textured to reduce sliding, 1/2" thick, UV protected  
8 pre-drilled stainless steel inserts to connect to Nardi table bases

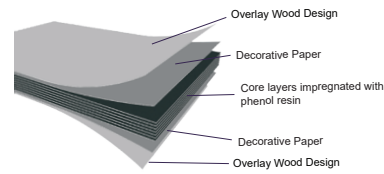

SILVER FABRIC	VINTAGE FLEETWOOD	VINTAGE PINE	SIZE	WGT.	MSRP	SELL
*TT-SV-SF 48X32	*TT-SV-VF 48X32	*TT-SV-VP 48X32	48"x32"	31 lbs	\$590	\$385
*TT-SV-SF 24X32	*TT-SV-VF 24X32	*TT-SV-VP 24X32	24"x32"	15 lbs	\$390	\$255
*TT-SV-SF 36SQ	*TT-SV-VF 36SQ	*TT-SV-VP 36SQ	36"	25 lbs	\$460	\$300
*TT-SV-SF 32SQ	*TT-SV-VF 32SQ	*TT-SV-VP 32SQ	32"	22 lbs	\$420	\$275
*TT-SV-SF 24SQ	*TT-SV-VF 24SQ	*TT-SV-VP 24SQ	24"	12 lbs	\$320	\$210

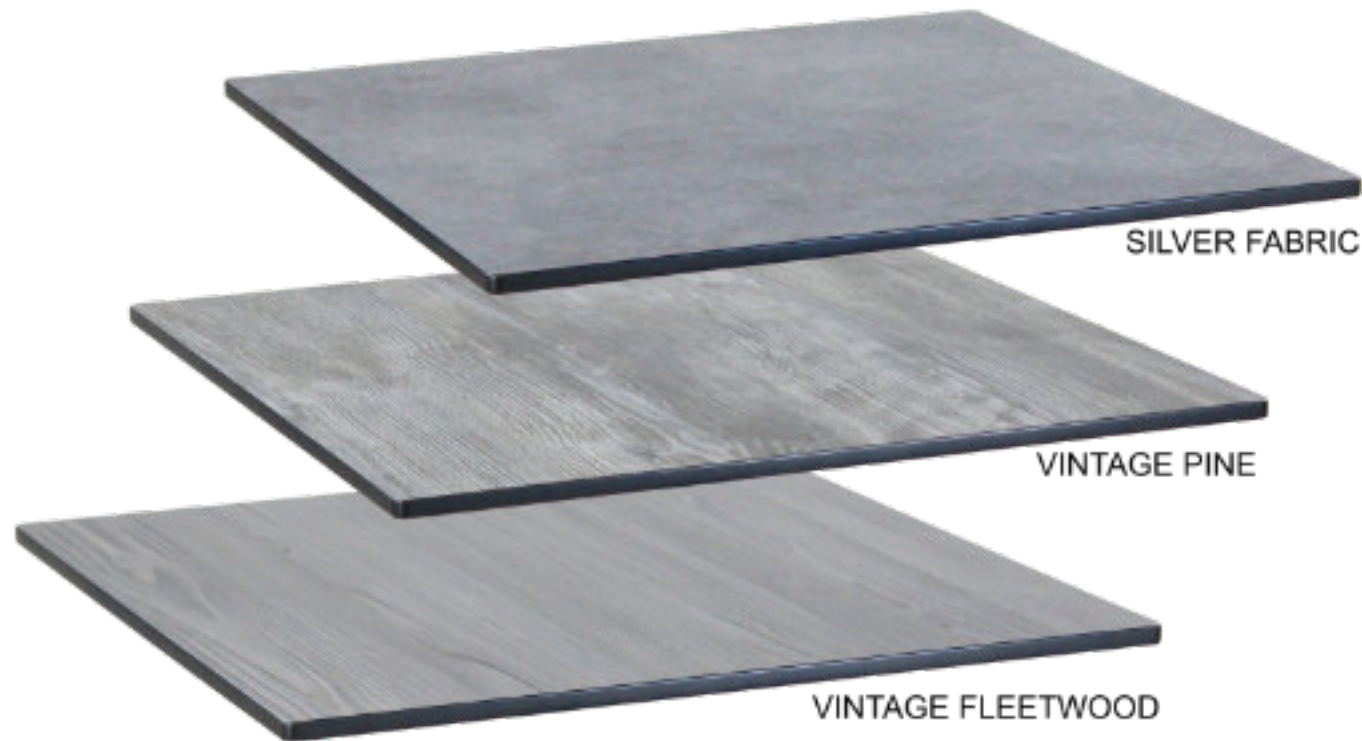

Marco Tabletops

100% Polymer Polywood tabletop, 1" thick, moisture resistant, UV protected,  
Works with any table base that is size appropriate



POLYWOOD GREY	POLYWOOD TEAK	SIZE	WGT.	MSRP	SELL
*TT-MARCO- 48X32-GREY	*TT-MARCO- 48X32-TEAK	48"x32"	36 lbs	\$570	\$370
*TT-MARCO- 24X32-GREY	*TT-MARCO- 24X32-TEAK	24"x32"	17 lbs	\$360	\$235
*TT-MARCO- 36RD-GREY	*TT-MARCO- 36RD-TEAK	36"	20 lbs	\$430	\$280
*TT-MARCO- 36SQ-GREY	*TT-MARCO- 36SQ-TEAK	36" SQ	32 lbs	\$520	\$340
*TT-MARCO- 32SQ-GREY	*TT-MARCO- 32SQ-TEAK	32" SQ	23 lbs	\$430	\$280
*TT-MARCO- 24SQ-GREY	*TT-MARCO- 24SQ-TEAK	24" SQ	13 lbs	\$290	\$190

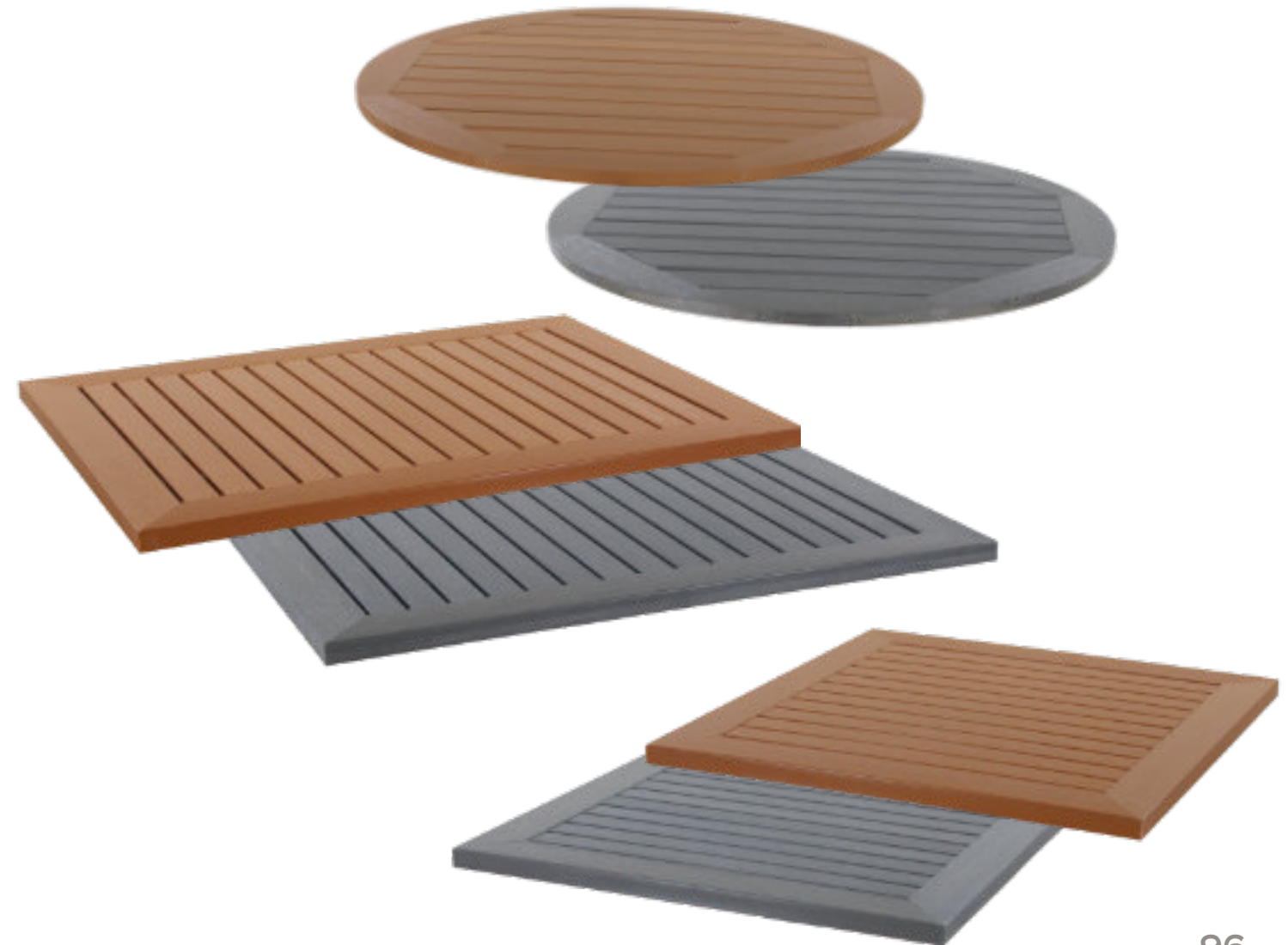



Bum Classic

Molded melamine mixed with redwood, 1" thick, UV protected  
8 pre-drilled stainless steel inserts to connect to Nardi table bases



ANTIQUE OAK	PINIE	PONDEROSA GREY	PONDEROSA WHITE	STRATTOS	WHITE	SIZE	WGT.	MSRP	SELL
*TT-SM-AO 48X32	*TT-SM-PN 48X32	*TT-SM-PG 48X32	*TT-SM-PW 48X32	*TT-SM-ST 48X32	*TT-SM-WH 48X32	48"x32"	36 lbs	\$390	\$255
*TT-SM-AO 24X32	*TT-SM-PN 24X32	*TT-SM-PG 24X32	*TT-SM-PW 24X32	*TT-SM-ST 24X32	*TT-SM-WH 24X32	24"x32"	17 lbs	\$280	\$190
*TT-SM-AO 32RD	*TT-SM-PN 32RD	*TT-SM-PG 32RD	*TT-SM-PW 32RD	*TT-SM-ST 32RD	*TT-SM-WH 32RD	32"	20 lbs	\$250	\$165
*TT-SM-AO 36SQ	*TT-SM-PN 36SQ	*TT-SM-PG 36SQ	*TT-SM-PW 36SQ	*TT-SM-ST 36SQ	*TT-SM-WH 36SQ	36"	32 lbs	\$340	\$220
*TT-SM-AO 32SQ	*TT-SM-PN 32SQ	*TT-SM-PG 32SQ	*TT-SM-PW 32SQ	*TT-SM-ST 32SQ	*TT-SM-WH 32SQ	32"	23 lbs	\$290	\$190
*TT-SM-AO 24SQ	*TT-SM-PN 24SQ	*TT-SM-PG 24SQ	*TT-SM-PW 24SQ	*TT-SM-ST 24SQ	*TT-SM-WH 24SQ	24"	13 lbs	\$190	\$125



TABLETOPS

# DINING HEIGHT BASES

REFER TO TABLETOP & BASE FIT GUIDE, PAGE 92



## Trail Self Leveling Bases

Say goodbye to wobbly tables! These award-winning bases use a simple mechanical system with four pivoting legs that are interconnected in such a way that when a table is placed on an uneven surface the feet will move until all feet are stable, E Plated Powder Coat finish

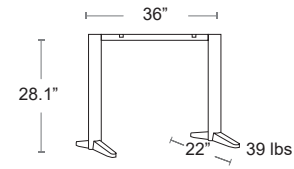

### Trail Dining Double

\*TB-NR-TTST22BK

LIST: \$720 EA.

SELL: \$470 EA.

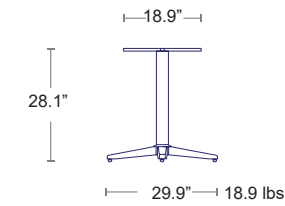

### Trail Dining 30

\*TB-NR-TRST30BK

LIST: \$480 EA.

SELL: \$310 EA.

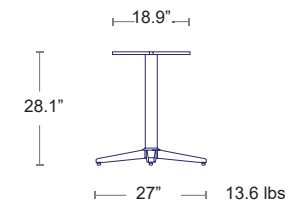

### Trail Dining 27

\*TB-NR-TRST27BK

LIST: \$400 EA.

SELL: \$260 EA.

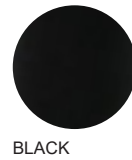

BLACK



# DINING HEIGHT BASES

REFER TO TABLETOP & BASE FIT GUIDE, PAGE 92



\*TB-NAR-536 + COLOR CODE

LIST: \$480 EA.

SELL: \$310 EA.

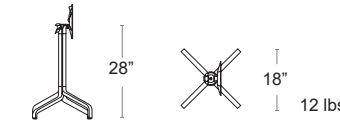

\*TB-NAR-532 + COLOR CODE

LIST: \$350 EA.

SELL: \$230 EA.

## Frasca Maxi Dining

Cast Aluminum, E-Plated Powder Coat finish + Specially Treated for High Salinity Environments



## Frasca Mini Tilt Dining

Cast Aluminum, E-Plated Powder Coat finish + Specially Treated for High Salinity Environments



ANTRACITE .52.01

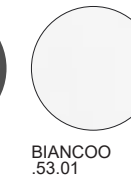

BIANCO .53.01

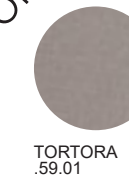

TORTORA .59.01

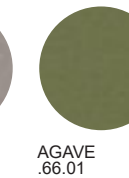

AGAVE .66.01



TABACCO .67.01

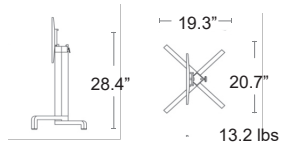

## Ibisco Tilt Dining

Cast Aluminum, E-Plated Powder Coat finish + Specially Treated for High Salinity Environments, Tilt top

LIST: \$330 EA. SELL: \$215 EA.



ANTRACITE \*TB-NAR-54552.01



WHITE \*TB-NAR-54553.01



SILVER \*TB-NAR-54554.01



TORTORA \*TB-NAR-54559.01



TABACCO \*TB-NAR-54567.01

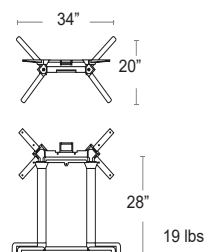
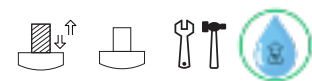

## Scudo Tilt Double Dining

Cast Aluminum, E-Plated Powder Coat finish + Specially Treated for High Salinity Environments

LIST: \$500 EA. SELL: \$325 EA.



ANTRACITE \*TB-NAR-54352.01



BIANCO \*TB-NAR-54353.01



SILVER \*TB-NAR-54354.01



TORTORA \*TB-NAR-54359.01

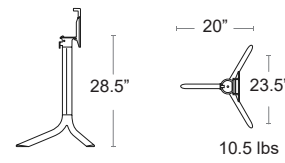

## Flute Tilt Dining

Cast Aluminum, E-Plated Powder Coat finish + Specially Treated for High Salinity Environments, Tilt top

LIST: \$320 EA. SELL: \$210 EA.



ANTRACITE \*TB-NAR-55652.01



WHITE \*TB-NAR-55653.01



SILVER \*TB-NAR-55654.01

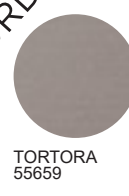

TORTORA 55659



## DINING HEIGHT BASES

REFER TO TABLETOP & BASE FIT GUIDE, PAGE 92



### Fiore Dining

Cast Aluminum, E-Plated Powder Coat finish + Specially Treated for High Salinity Environments



LIST: \$270 EA.    SELL: \$175 EA.

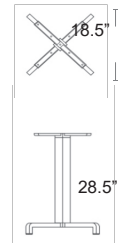

11 lbs



ANTRACITE  
\*TB-NAR-53052.01



SILVER  
\*TB-NAR-53054.01

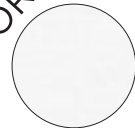

WHITE  
\*TB-NAR-53053.01

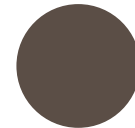

TABACCO  
\*TB-NAR-53057.01



TORTORA  
\*TB-NAR-53059.01



### Clip Dining

Tubular resin and fiberglass legs, UV Protected

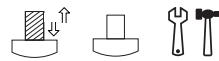

LIST: \$220 EA.    SELL: \$145 EA.



17.9 lbs



ANTRACITE  
\*TB-NAR-40088.02

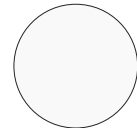

BIANCO  
\*TB-NAR-40088.00



TORTORA  
\*TB-NAR-40088.10



AGAVE  
\*TB-NAR-40088.16



TABACCO  
\*TB-NAR-40088.53

IF YOU DON'T SEE WHAT YOU WANT,  
JUST ASK.

WE COLLABORATE  
WITH FACTORIES WORLDWIDE  
TO BRING YOUR VISION TO LIFE

## BAR HEIGHT BASES



# BAR HEIGHT BASES

REFER TO TABLETOP & BASE FIT GUIDE, PAGE 92



## Scudo Tilt Double Bar

Cast Aluminum, E-Plated Powder Coat finish + Specially Treated for High Salinity Environments

**LIST: \$560 EA.    SELL: \$365 EA.**

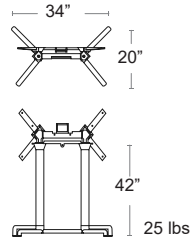
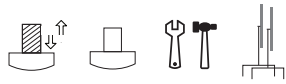

## Trail Self Leveling Bases

Say goodbye to wobbly tables!  
These award-winning bases use a simple mechanical system with four pivoting legs that are interconnected in such a way that when a table is placed on an uneven surface the feet will move until all feet are stable. E-Plated Powder Coat finish

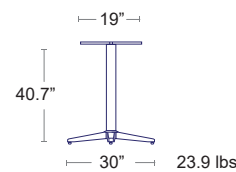

### Trail Bar 30

\*TB-NR-TRST30BKB

**LIST: \$540 EA.  
SELL: \$350 EA.**

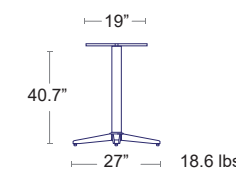

### Trail Bar 27

\*TB-NR-TRST27BKB

**LIST: \$500 EA.  
SELL: \$325 EA.**

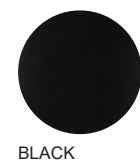

# BAR HEIGHT BASES

REFER TO TABLETOP & BASE FIT GUIDE, PAGE 92



## Frasca Tilt Bar

Cast Aluminum, E-Plated Powder Coat finish + Specially Treated for High Salinity Environments

**LIST: \$390 EA.    SELL: \$255 EA.**

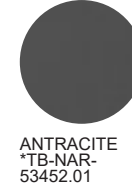
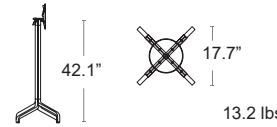
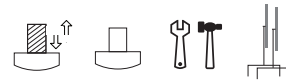

## Ibisco Tilt Bar

Cast Aluminum, Powder Coat + Specially Treated for High Salinity Environments

**LIST: \$370 EA.    SELL: \$240 EA.**

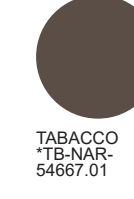
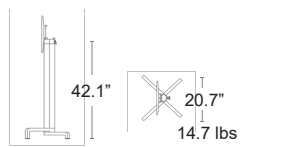
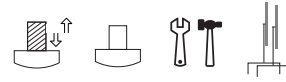

## Fiore Bar

Cast Aluminum, E-Plated Powder Coat finish + Specially Treated for High Salinity Environments

**LIST: \$320 EA.    SELL: \$210 EA.**

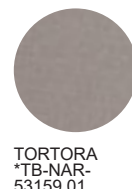
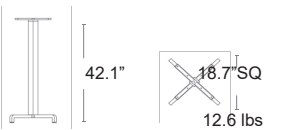
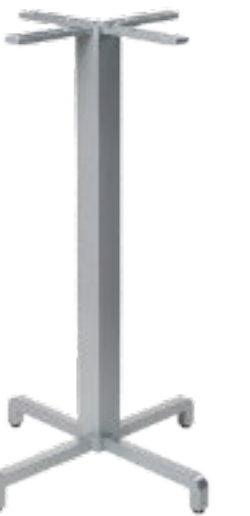
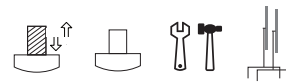

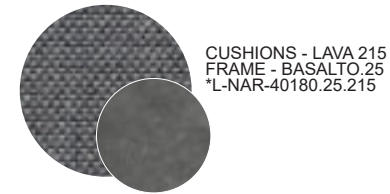
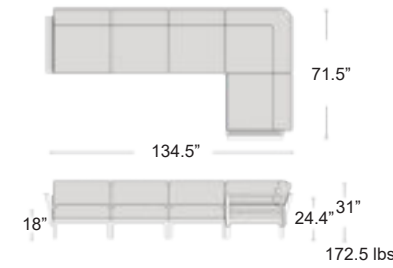

CUSHIONS - LAVA 215  
FRAME - BASALTO.25  
\*L-NAR-40180.25.215

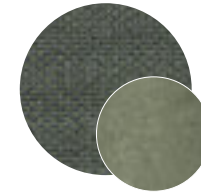

CUSHIONS - TIMO 217  
FRAME - CACTUS 27  
\*L-NAR-40180.27.217

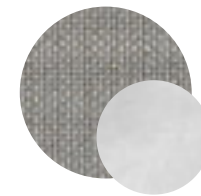

CUSHIONS - PERLA 213  
FRAME - GESSO 29  
\*L-NAR-40180.29.213

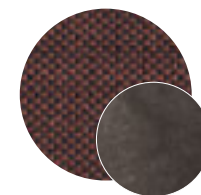

CUSHIONS -CANNELLA 219  
FRAME - TERRA 44  
\*L-NAR-40180.44.219

Maximo 5 Sofa Set **regeneration**

Uniformly colored fiberglass and polypropylene with UV additives, Matte finish, Non-slip feet, Recyclable  
The Nardi Regeneration industrial program is creating a line of outdoor furniture specifically dedicated to regenerated plastic products, made of post-industrial and post-consumer polypropylene, which can in turn be recycled

**LIST: \$6510 EA.    SELL: \$4230 EA.**

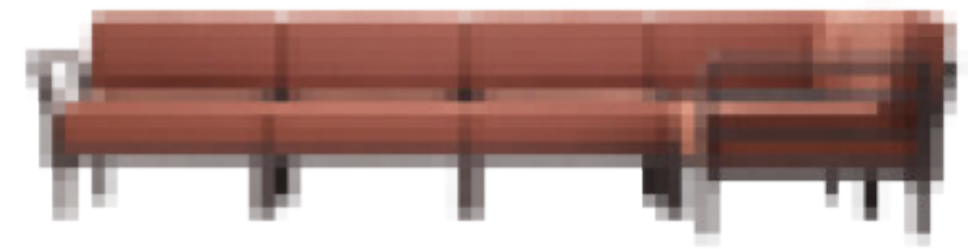
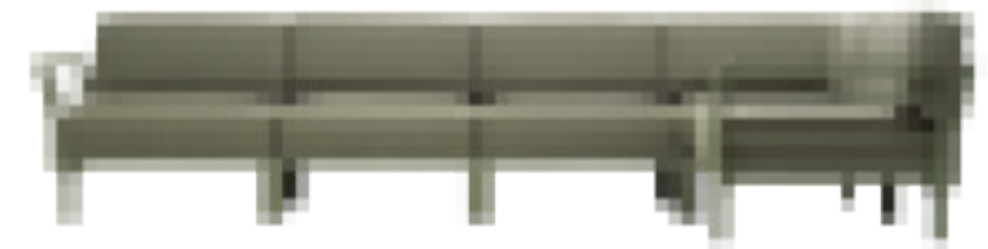

# LOUNGE SEATING



## Maximo Modular Deep Seating Collection

Maximo is an outdoor seating system of elements that can be connected as you see fit to suit your patio requirements. Uniformly colored fiberglass and polypropylene with UV additives, Matte finish, Non-slip feet, Recyclable. Using the components we stock you can make any of the chairs or sofas in the collection

### CORNER MODULE

**LIST: \$1430 EA.**  
**SELL: \$930 EA.**



\*L-NAR-40184.+ FRAME & FABRIC COLOR CODES

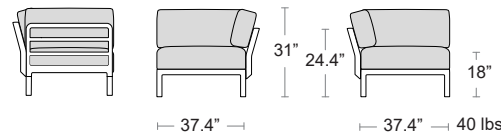

### ARMLESS MODULE

**LIST: \$1220 EA.**  
**SELL: \$795 EA.**



\*L-NAR-40183.+ FRAME & FABRIC COLOR CODES

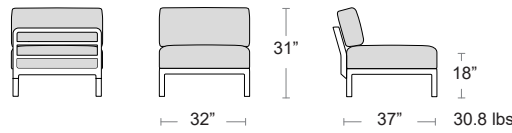

### POUF/OTTOMAN

**LIST: \$880 EA.**  
**SELL: \$570 EA.**



\*L-NAR-40179.+ FRAME & FABRIC COLOR CODES

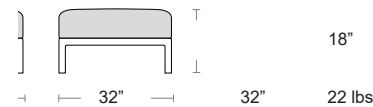

### COFFEE TABLE

**LIST: \$410 EA.**  
**SELL: \$270 EA.**



\*L-NAR-40178.+ COLOR CODE

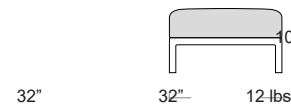

# LOUNGE SEATING

## Curved Arm/Back

**LIST: \$160 EA.**  
**SELL: \$105 EA.**

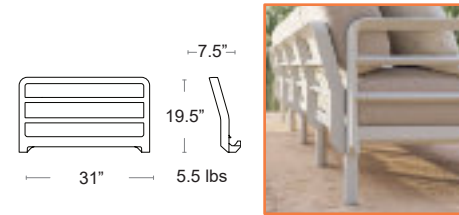

\*L-NAR-40186.+ COLOR CODE

## Straight Arm/Back

**LIST: \$120 EA.**  
**SELL: \$80 EA.**

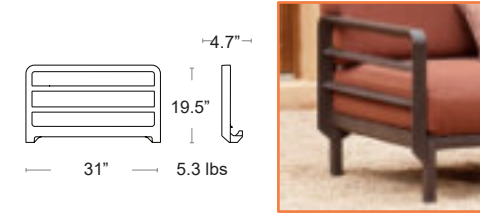

\*L-NAR-40185.+ COLOR CODE

## Shelf Module

**LIST: \$110 EA.**  
**SELL: \$75 EA.**

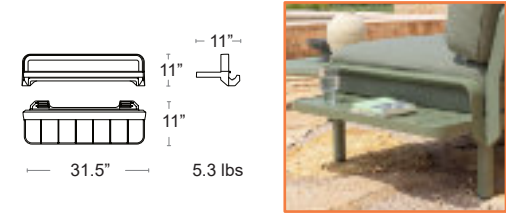

\*L-NAR-40188.+ COLOR CODE

## Toss Pillow 19.5"x19.5"

\*C-NAR-36180.01+COLOR CODE

**LIST: \$160 EA.**      **SELL: \$105 EA.**



PERLA .214



TIMO .218



LAVA .216



CANNELLA .220

## Bolster Pillow 24"x16"

\*C-NAR-36180.02+COLOR CODE

**LIST: \$140 EA.**      **SELL: \$90 EA.**



PERLA .214



LAVA .216



TIMO .218



CANNELLA .220

# LOUNGE SEATING

## Upholstery & Frame Color Combinations.

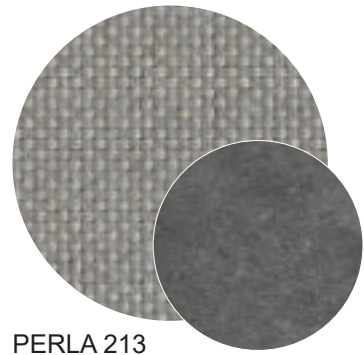

PERLA 213  
BASALTO.25

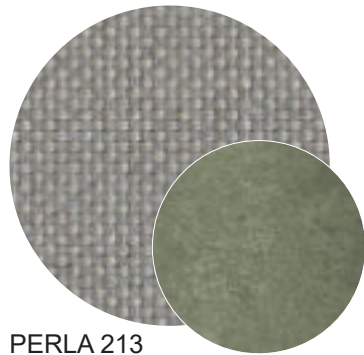

PERLA 213  
CACTUS 27



PERLA 213  
GESSO 29

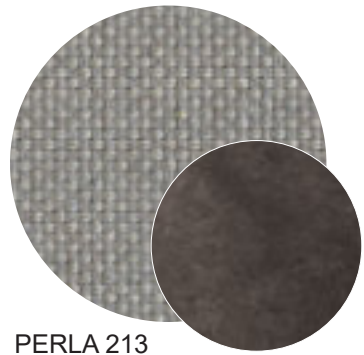

PERLA 213  
TERRA 44

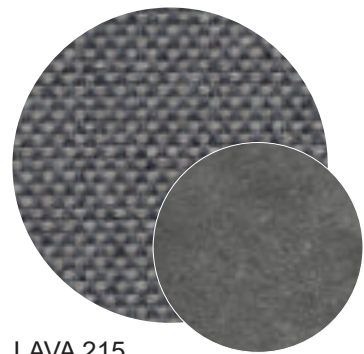

LAVA 215  
BASALTO.25

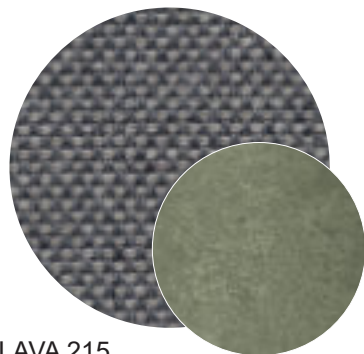

LAVA 215  
CACTUS 27

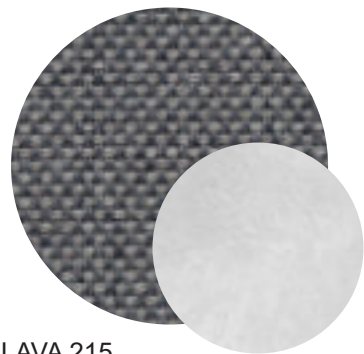

LAVA 215  
GESSO 29

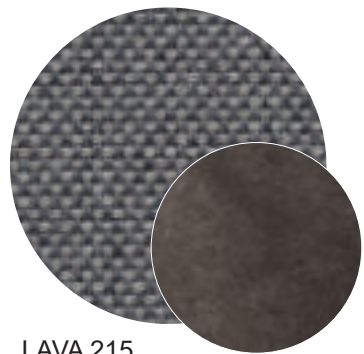

LAVA 215  
TERRA 44

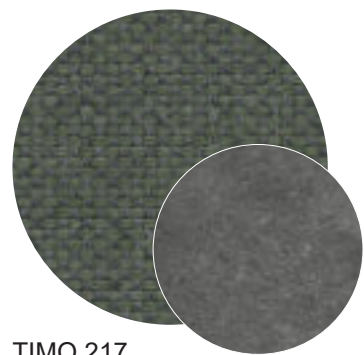

TIMO 217  
BASALTO.25

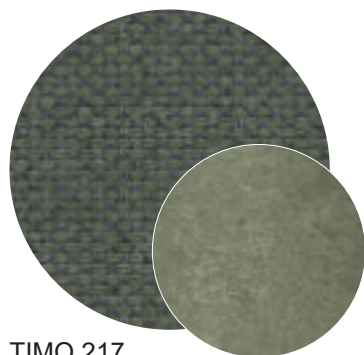

TIMO 217  
CACTUS 27

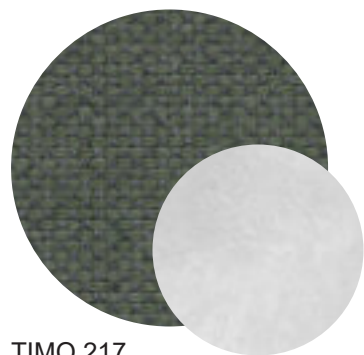

TIMO 217  
GESSO 29

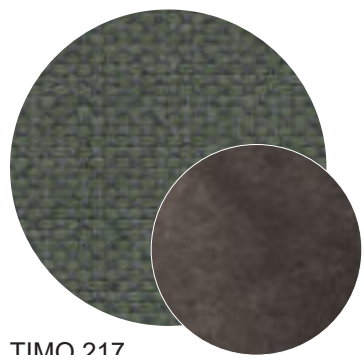

TIMO 217  
TERRA 44

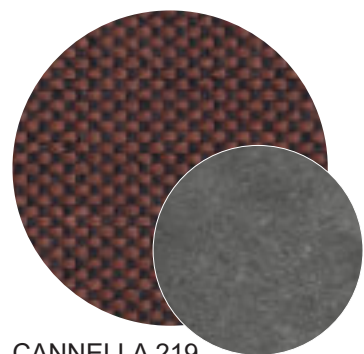

CANNELLA 219  
BASALTO.25

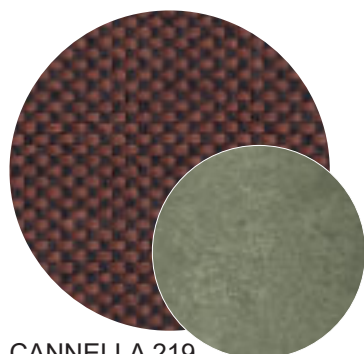

CANNELLA 219  
CACTUS 27

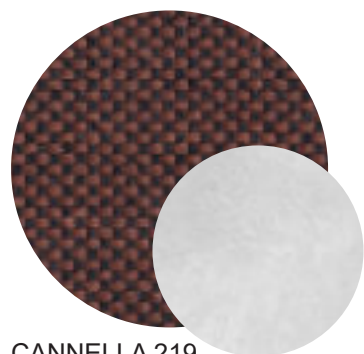

CANNELLA 219  
GESSO 29

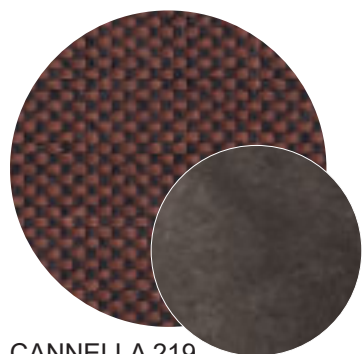

CANNELLA 219  
TERRA 44

# LOUNGE SEATING



## Amalfi Collection

A modern take on a classic design made from high density polyethylene (HDPE), Very high impact resistance with a textured finish, UV protected

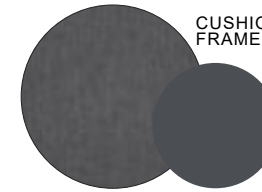
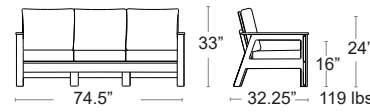
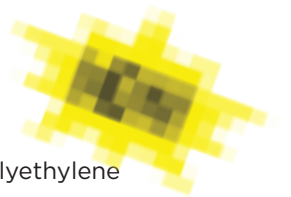

CUSHIONS - SUNBRELLA CAST CHARCOAL  
FRAME - CHARCOAL

### Sofa

LIST: \$2900 EA.

SELL: \$1885 EA.

\*L-BUM-AMALFI SOFA





# LOUNGE SEATING

## Loveseat

**LIST: \$1880 EA.**

\*L-BUM-AMALFI LOVE

**SELL: \$1220 EA.**

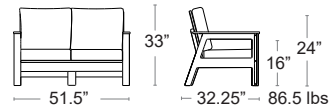

## Club Chair

**LIST: \$1100 EA.**

\*L-BUM-AMALFI CHAIR

**SELL: \$715 EA.**

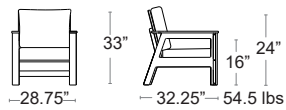

# LOUNGE SEATING



## REPLACEMENT CUSHIONS

Module	MSRP	SELL
Long Sofa 00L +02R	\$1750	\$1140
Sofa 581	\$1350	\$880
Love Seat 582	\$1060	\$690
Swivel Armchair 586	\$700	\$455
Recliner Armchair 571	\$700	\$455
Club Chair 583	\$700	\$455
Left 02L or Right 02R	\$1000	\$550
Corner 00C	\$1070	\$695
Double Armless 02A	\$940	\$610
Armless 00A	\$690	\$450
Ottoman 50B	\$290	\$190

## City View Deep Seating Collection

E-Plated Powder Coat finish, welded Aluminum frame, sling seat and back for added comfort

Includes Sunbelievable cushions, zippered for easy cleaning  
Replacement or Custom Color cushions available

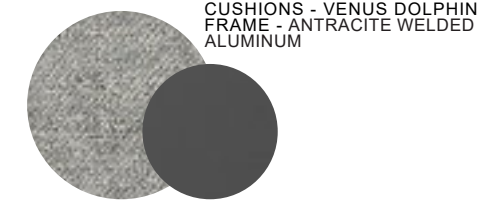

CUSHIONS - VENUS DOLPHIN  
FRAME - ANTRACITE WELDED ALUMINUM

## Sofa

**LIST: \$3800 EA.**

**SELL: \$2470 EA.**

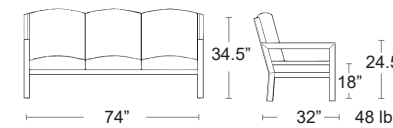

\*L-BUM-CITYVIEW-581 SOFA

## Love Seat

**LIST: \$2680 EA.**

**SELL: \$1740 EA.**

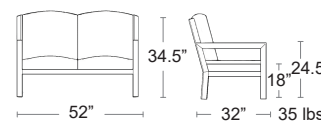

\*L-BUM-CITYVIEW-582 LS

**LOUNGE SEATING**

**LOUNGE SEATING**

**NEW!**

Recliner High Back Armchair  
 LIST: \$1920 EA.    **SELL: \$1250 EA.**



\*L-BUM-CITYVIEW-511

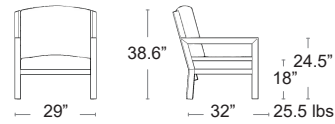

**NEW!**

Swivel Armchair  
 LIST: \$1740 EA.    **SELL: \$1130 EA.**



\*L-BUM-CITYVIEW-586



Club Chair  
 LIST: \$1740 EA.    **SELL: \$1130 EA.**



\*L-BUM-CITYVIEW-583 CLUB

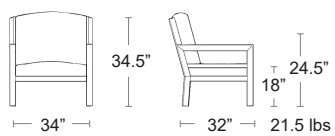

City View Modular Collection

Long Sofa  
 LIST: \$5100 EA.    **SELL: \$3315 EA.**

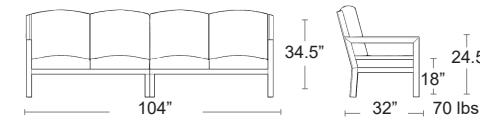

\*L-BUM-CITYVIEW-02R+02L

Right or Left  
 LIST: \$2550 EA.    **SELL: \$1660 EA.**

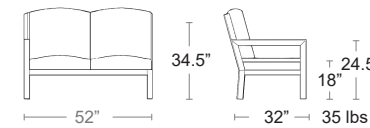

\*L-BUM-CITYVIEW-02R



\*L-BUM-CITYVIEW-02L

# LOUNGE SEATING

Corner  
**LIST: \$2690 EA.    SELL: \$1750 EA.**

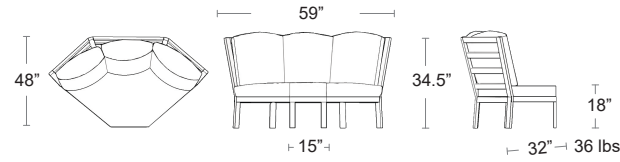

\*L-BUM-CITYVIEW-00C



Double Armless  
**LIST: \$2600 EA.    SELL: \$1690 EA.**

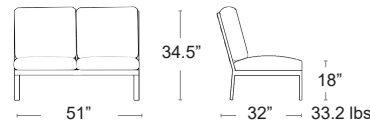

\*L-BUM-CITYVIEW-02A



Slipper  
**LIST: \$1380 EA.    SELL: \$900 EA.**

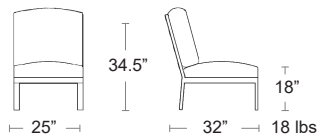

\*L-BUM-CITYVIEW-00A



Ottoman  
**LIST: \$800 EA.    SELL: \$520 EA.**

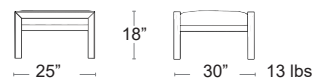

\*L-BUM-CITYVIEW-508



# LOUNGE SEATING



Module	MSRP	SELL
Long Sofa	\$1440	\$935
Sofa SKY-581	\$1008	\$655
Love Seat SKY-582	\$720	\$470
Club Chair SKY-583	\$480	\$315
Left 02L14 or Right 02R14	\$720	\$470
Corner SKY-00C	\$480	\$315
Armless SKY-00A	\$380	\$250

## Skyline Deep Seating Collection

All weather polyethylene wicker double fish bone weave, pattern for extra strength and durability, hand woven. Fully welded aluminum frame, E-Plated Powder Coat finish. Includes Sunbrella cushions, zippered for easy cleaning. Replacement or Custom Color cushions available.



CUSHIONS - SUNBRELLA VOLT SILVER  
 FRAME - POLYETHYLENE ALL WEATHER  
 WICKER

SKY CUSHION BOX  
**LIST: \$3200 EA.    SELL: \$2080 EA.**

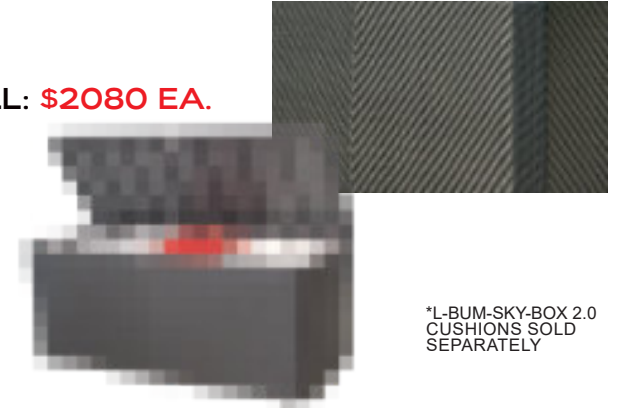
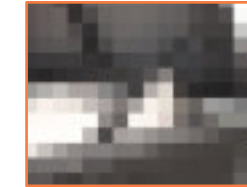
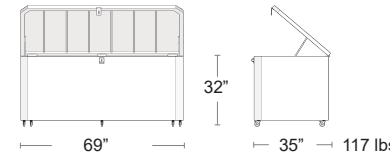

\*L-BUM-SKY-BOX.2.0  
 CUSHIONS SOLD SEPARATELY

SOFA  
**LIST: \$3120 EA.    SELL: \$2030 EA.**

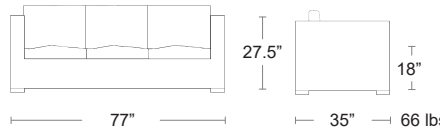

\*@L-BUM-SKY-581

LOVE SEAT  
**LIST: \$2250 EA.    SELL: \$1265 EA.**

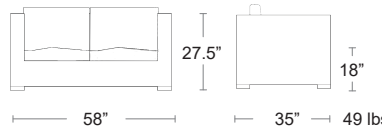

\*@L-BUM-SKY-582

CLUB CHAIR  
**LIST: \$1520 EA.    SELL: \$990 EA.**

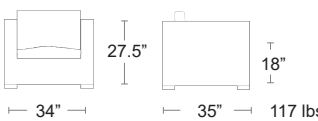

\*@L-BUM-SKY-583

# LOUNGE SEATING

## Skyline Modular Collection

### LONG SOFA

LIST: \$4500 EA. SELL: \$2915 EA.

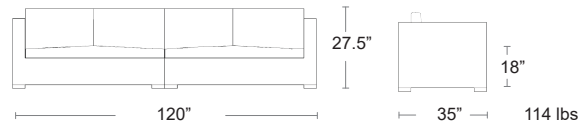

\*@L-BUM-SKY LONG

### RIGHT & LEFT

LIST: \$2250 EA. SELL: \$1465 EA.

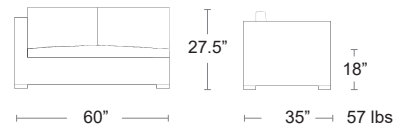

\*@L-BUM-SKY-02R14



\*@L-BUM-SKY-02L14

### CORNER

LIST: \$1510 EA. SELL: \$985 EA.

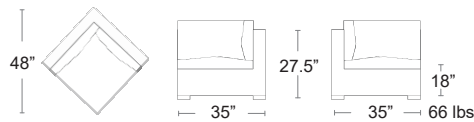

\*@L-BUM-SKY-00C

### SLIPPER

LIST: \$1180 EA. SELL: \$770 EA.

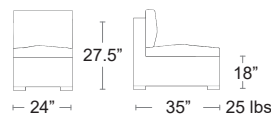

\*@L-BUM-SKY-00A

# LOUNGE SEATING



Module	MSRP	SELL
Sofa 581	\$950	\$625
Love Seat 582	\$660	\$430
Club Chair 583	\$420	\$275
Long Sofa	\$2110	\$1375
Left 02LM or Right 02RM	\$720	\$470
Corner 00CM	\$480	\$315
Armless 00AM	\$400	\$260

## Urban Deep Seating Collection

Welded aluminum frame, E-Plated Powder Coat finish, sling seat and back for added comfort  
Includes Sunbelievable cushions, zippered for easy cleaning  
Replacement or Custom Color cushions available

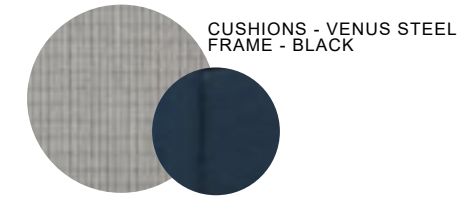

### SOFA

LIST: \$3060 EA. SELL: \$1990 EA.

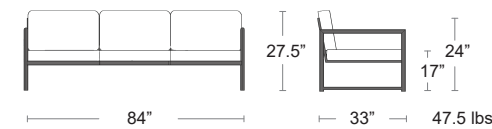

\*L-BUM-URBAN-581

### LOVE SEAT

LIST: \$2050 EA. SELL: \$1335 EA.

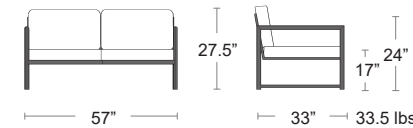

\*L-BUM-URBAN-582

### CLUB CHAIR

LIST: \$870 EA. SELL: \$565 EA.

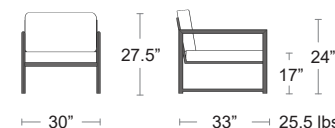

\*L-BUM-URBAN-583

# LOUNGE SEATING

## Urban Modular Collection

### LONG SOFA

LIST: \$4450 EA. **SELL: \$2900 EA.**

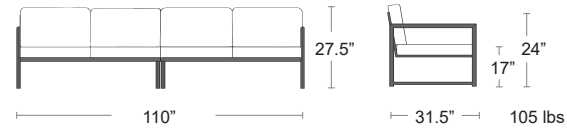

\*L-BUM-URBAN- URBAN LONG

### RIGHT & LEFT MODULE

LIST: \$2200 EA. **SELL: \$1430 EA.**

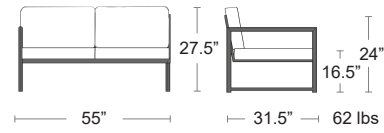

\*L-BUM-URBAN-02RM



\*L-BUM-URBAN-02LM

### CORNER

LIST: \$1500 EA. **SELL: \$975 EA.**

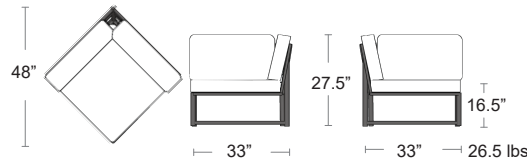

\*L-BUM-URBAN-00CM

### ARMLESS

LIST: \$1230 EA. **SELL: \$800 EA.**

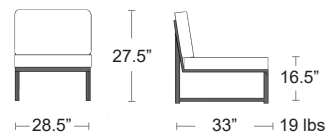

\*L-BUM-URBAN-00AM

# LOUNGE SEATING

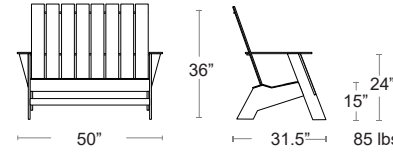

## Lakeshore Loveseat

A classic design made from high density polyethylene (HDPE), Very high impact resistance with a textured finish, UV protected

LIST: \$1270 EA. **SELL: \$825 EA.**

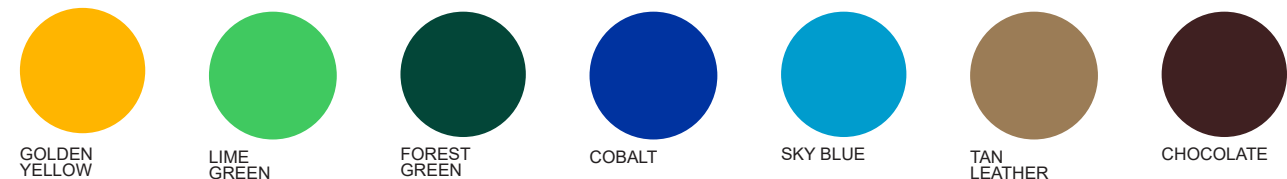

# LOUNGE SEATING



## Lakeshore Lounge





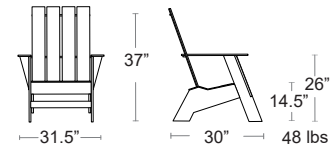

A classic design made from high density polyethylene (HDPE), Very high impact resistance with a textured finish, UV protected

LIST: \$690 EA.      SELL: \$450 EA.



-  \*L-BS-BMAK-BLACK
-  \*L-BS-BMAK-WHITE
-  \*L-BS-BMAK-GREY
-  \*L-BS-BMAK-RED

 SPECIAL ORDER

-  GOLDEN YELLOW
-  LIME GREEN
-  FOREST GREEN
-  COBALT
-  SKY BLUE
-  TAN LEATHER
-  CHOCOLATE



# LOUNGE SEATING



## Folio

Reclining armchair. Uniformly colored fiberglass polypropylene resins with UV additives. Matte finish, non-slip replaceable feet.

LIST: \$400 EA.      SELL: \$260 EA.

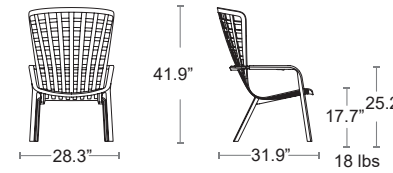
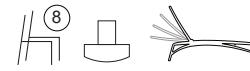

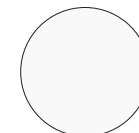
-  BIANCO  
\*L-NAR-40300.00.04
-  ANTRACITE  
\*L-NAR-40300.02.04
-  TORTORA  
\*L-NAR-40300.10.04
-  AGAVE  
\*L-NAR-40300.16.04
-  SPECIAL ORDER
-  TABACCO  
\*L-NAR-40300.53.04



# LOUNGE SEATING



## Folio Accessories Rocker Kit

Turn your Folio into a rocking chair with the rocker accessory

**LIST: \$80 EA.    SELL: \$50 EA.**

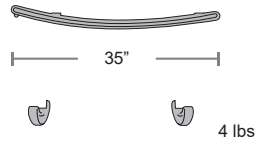

**SPECIAL ORDER**

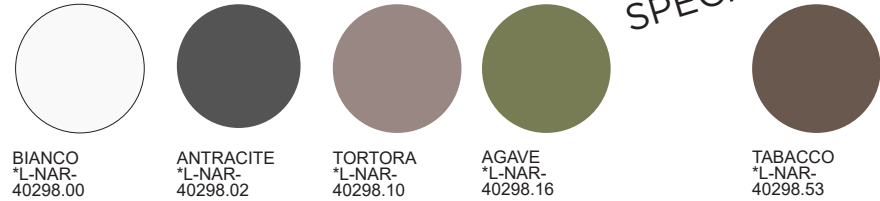

## Cushion

Acrylic yarn dyed fabric with polyurethane foam and Velcro straps

**LIST: \$340 EA.  
SELL: \$220 EA.**

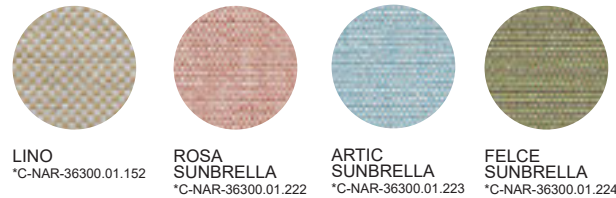

**LIST: \$250 EA.  
SELL: \$165 EA.**

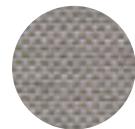

GRIGIO  
\*C-NAR-36300.01.163



## Headrest

Acrylic yarn dyed fabric with polyurethane foam and Velcro straps

**LIST: \$90 EA.  
SELL: \$60 EA.**



LINO  
\*C-NAR-36300.04.152

ROSA SUNBRELLA  
\*C-NAR-36300.04.222

ARTIC SUNBRELLA  
\*C-NAR-36300.04.223

FELCE SUNBRELLA  
\*C-NAR-36300.04.224

GRIGIO  
\*C-NAR-36300.04.163

**LIST: \$70 EA.  
SELL: \$45 EA.**

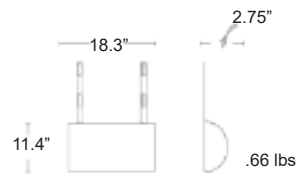

# LOUNGE SEATING



## Poggio Stool/Footrest

Uniformly colored fiberglass polypropylene resins with UV additives, Matte finish

**LIST: \$120 EA.    SELL: \$80 EA.**

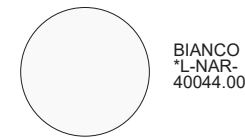
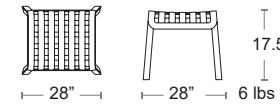

BIANCO  
\*L-NAR-40044.00

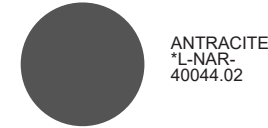

ANTRACITE  
\*L-NAR-40044.02

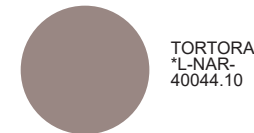

TORTORA  
\*L-NAR-40044.10

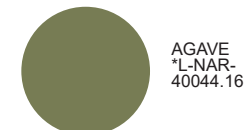

AGAVE  
\*L-NAR-40044.16

**SPECIAL ORDER**

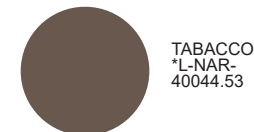

TABACCO  
\*L-NAR-40044.53



# LOUNGE SEATING



## Net Bench

Uniformly colored fiberglass and polypropylene with UV additives, Matte finish, Non-slip feet, Recyclable resin. See in stock cushions Page 129

LIST: \$370 EA.    SELL: \$240 EA.

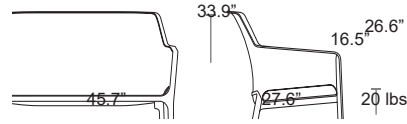

# LOUNGE SEATING



## Net Relax

Uniformly colored fiberglass and polypropylene with UV additives, Matte finish, Non-slip feet, Recyclable resin. See in stock cushions Page 129

LIST: \$220 EA.    SELL: \$145 EA.

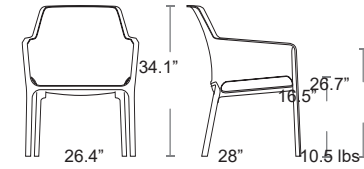



# LOUNGE SEATING



## Net Lounge

Uniformly colored fiberglass and polypropylene with UV additives, Matte finish, Non-slip feet, Recyclable resin.

LIST: \$340 EA.    SELL: \$220 EA.

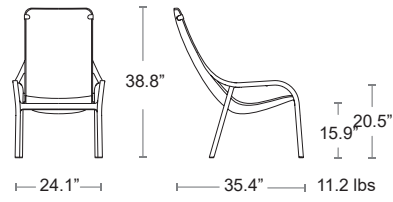

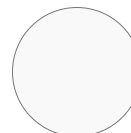
-  BIANCO  
\*L-NAR-40329.00
-  ANTRACITE  
\*L-NAR-40329.02
-  SALICE  
\*L-NAR-40329.04
-  TORTORA  
\*L-NAR-40329.10
-  SENAPE  
\*L-NAR-40329.56
-  CORALLO  
\*L-NAR-40329.75





## Headrest Cushion

With adjustable straps, Washable on delicate setting, 100% yarn dyed acrylic UV treated, dirt repellent & Mold resistant

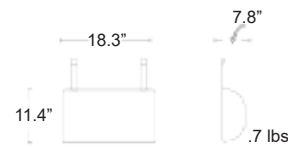
LIST: \$70 EA.    SELL: \$45 EA.



-  ROSA QUARZO  
36329.04.066
-  SENAPE  
36329.04.069
-  GRIGIO  
36329.04.136

# LOUNGE SEATING









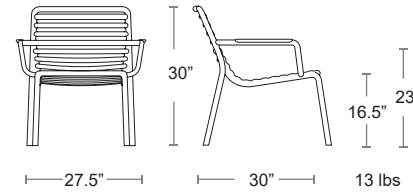
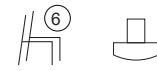

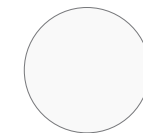
## Doga Relax

Uniformly colored fiberglass and polypropylene with UV additives, Matte finish, Non-slip feet, Recyclable resin, See in stock cushions Page 129

LIST: \$270 EA.    SELL: \$175 EA.



-  BIANCO  
\*L-NAR-40256.00
-  ANTRACITE  
\*L-NAR-40256.02
-  AGAVE  
\*L-NAR-40256.16
-  PERA  
\*L-NAR-40256.18
-  MARSALA  
\*L-NAR-40256.21
- 
-  CAPPUCINO  
\*L-NAR-40256.14
-  MENTA  
\*L-NAR-40256.15
-  TABACCO  
\*L-NAR-40256.53



# LOUNGE SEATING



## Lounge Cushions

Made in North America, Sunbrella 100% Solution dyed acrylic, Zippered removable cover, washable, Custom Sunbrella Colors available for a 25% Surcharge

### Net Bench

No ties

\*C-BUM-NET-BENCH  
+ COLOR CODE  
**LIST: \$230 EA.**  
**SELL: \$150 EA.**

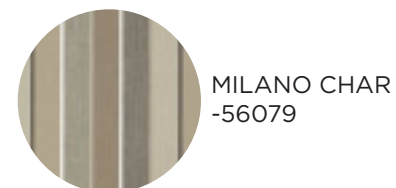
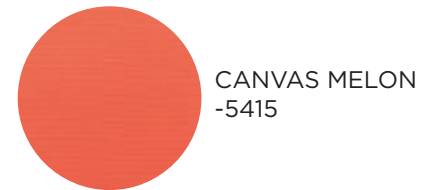
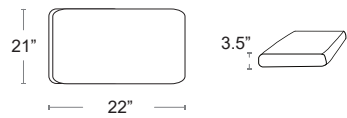

### Doga Relax

Velcro ties

\*C-BUM-DOGA-RELAX  
+ COLOR CODE  
**LIST: \$200 EA.**  
**SELL: \$130 EA.**

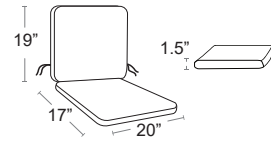

### Net Relax

No ties

\*C-BUM-NET-RELAX  
+ COLOR CODE  
**LIST: \$120 EA.**  
**SELL: \$80 EA.**

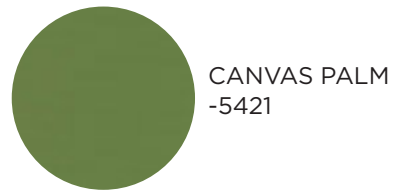
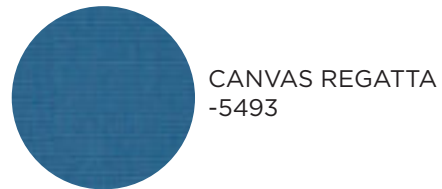
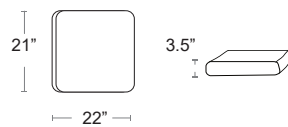

### Custom Cushions & Special Orders

We can make cushions for all the chairs and stools we sell in available Sunbrella Fabric  
We have swatches and samples of Special Order colors and fabrics.  
Contact BUM for samples and pricing [samplerrequest@bumoutdoor.ca](mailto:samplerrequest@bumoutdoor.ca)

# LOUNGE SEATING



## Throw Pillows

Sunbrella 100% Solution Dyed acrylic, Washable zippered removable cover  
Complements the Net and Deep Seating lounge collections  
Custom Sunbrella cushions available for a 25% surcharge, expect 3 weeks for delivery

**LIST: \$80 EA.**    **SELL: \$40 EA.**

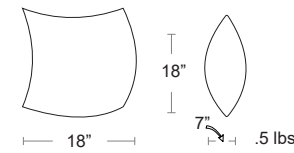

**Toss**  
\*C-BUM-TOSS + COLOR CODE

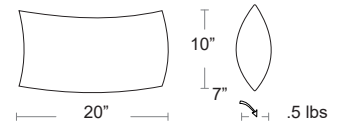

**Bolster**  
\*C-BUM-BOLSTER + COLOR CODE



### Custom Cushions & Special Orders

We can make cushions for all the chairs and stools we sell in available Sunbrella Fabric  
We have swatches and samples of Special Order colors and fabrics.  
Contact BUM for samples and pricing [samplerrequest@bumoutdoor.ca](mailto:samplerrequest@bumoutdoor.ca)

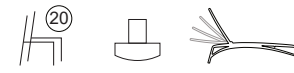

Wave Sun Lounger

Stackable polypropylene and aluminum frame with water resistant seat material

LIST: \$560 EA.

SELL: \$365 EA.

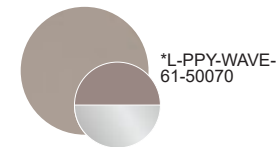
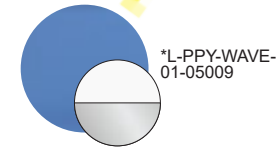
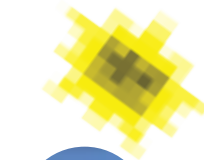
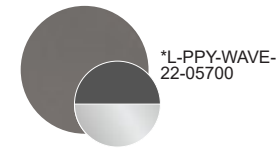
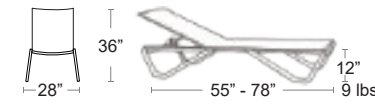



Jakarta Teak Collection

Solid Teak construction, Teak will develop a warm gray patina over time or it can be oiled annually to maintain the look of new wood.

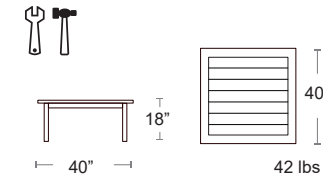

Coffee Table  
\*L-BUM-TEAK.COFFEE  
**LIST: \$1070 EA.**  
**SELL: \$695 EA.**

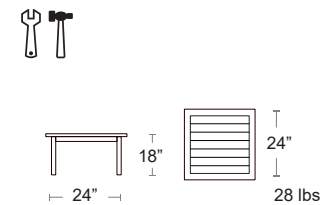

Side Table  
\*L-BUM-TEAK.SIDE  
**LIST: \$730 EA.**  
**SELL: \$475 EA.**

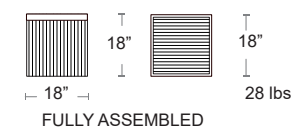

Cube Side Table/Stool  
\*L-BUM-TEAK.CUBE  
**LIST: \$700 EA.**  
**SELL: \$455 EA.**

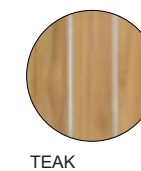

# LOUNGE TABLES



## Amalfi/Lakeshore Collection

A classic design made from high density polyethylene (HDPE), Very high impact resistance with a textured finish, UV protected

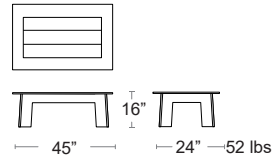

### Coffee Table

\*L-BS-BSMRC + COLOR

**LIST: \$770 EA.**  
**SELL: \$500 EA.**

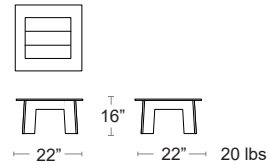

### Side Table

\*L-BS-BSMOS + COLOR

**LIST: \$580 EA.**  
**SELL: \$380 EA.**

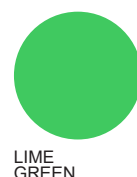

# LOUNGE TABLES



## Urban Collection

Welded Aluminum frame, E-Plated Powder Coat finish

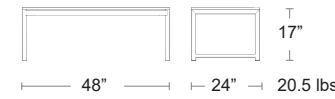

### Coffee Table

\*@L-BUM-URBAN-2448

**LIST: \$1040 EA.**  
**SELL: \$520 EA.**

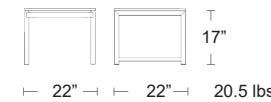

### Side Table

\*@L-BUM-URBAN-22SQ

**LIST: \$650 EA.**  
**SELL: \$325 EA.**



## City View Collection

Welded Aluminum frame, E-Plated Powder Coat finish

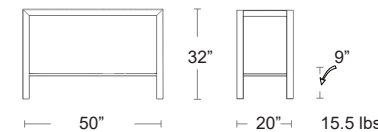

### Console Table

\*L-BUM-CITYVIEW-2050T

**LIST: \$1080 EA.**  
**SELL: \$700 EA.**

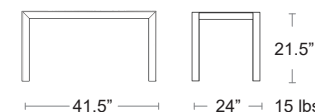

### Coffee Table

\*L-BUM-CITYVIEW-2442

**LIST: \$890 EA.**  
**SELL: \$580 EA.**

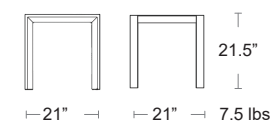

### Side Table

\*L-BUM-CITYVIEW-20SQ

**LIST: \$510 EA.**  
**SELL: \$330 EA.**



## LOUNGE TABLES



### Skyline Tables

All weather wicker fish bone weave, Welded aluminum frame, E-Plated Powder Coat finish, Frosted glass top

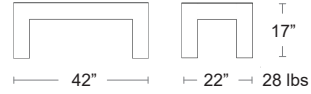

### Coffee Table

\*@-L-BUM-SKY-4222C

LIST: \$720 EA.

SELL: \$470 EA.

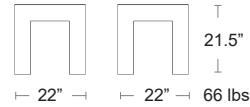

### Side Table

\*@-L-BUM-SKY-22SQ

LIST: \$650 EA.

SELL: \$425 EA.



“ELEVATING SPACES  
WITH COMMERCIAL FURNITURE THAT  
COMBINES STYLE, STRENGTH,  
& SUSTAINABILITY”

“STYLE YOU CAN SIT ON,  
QUALITY YOU CAN RELY ON”

“BUM IS YOUR ONE-STOP SHOP FOR  
COMMERCIAL OUTDOOR FURNITURE –  
QUALITY, VARIETY, AND STYLE,  
ALL IN ONE PLACE”

## LOUNGE TABLES



### Net 100

Uniformly colored fiberglass polypropylene with UV additives  
Perforated top, Matte finish, Non-slip feet, Recyclable

LIST: \$200 EA. SELL: \$130 EA.

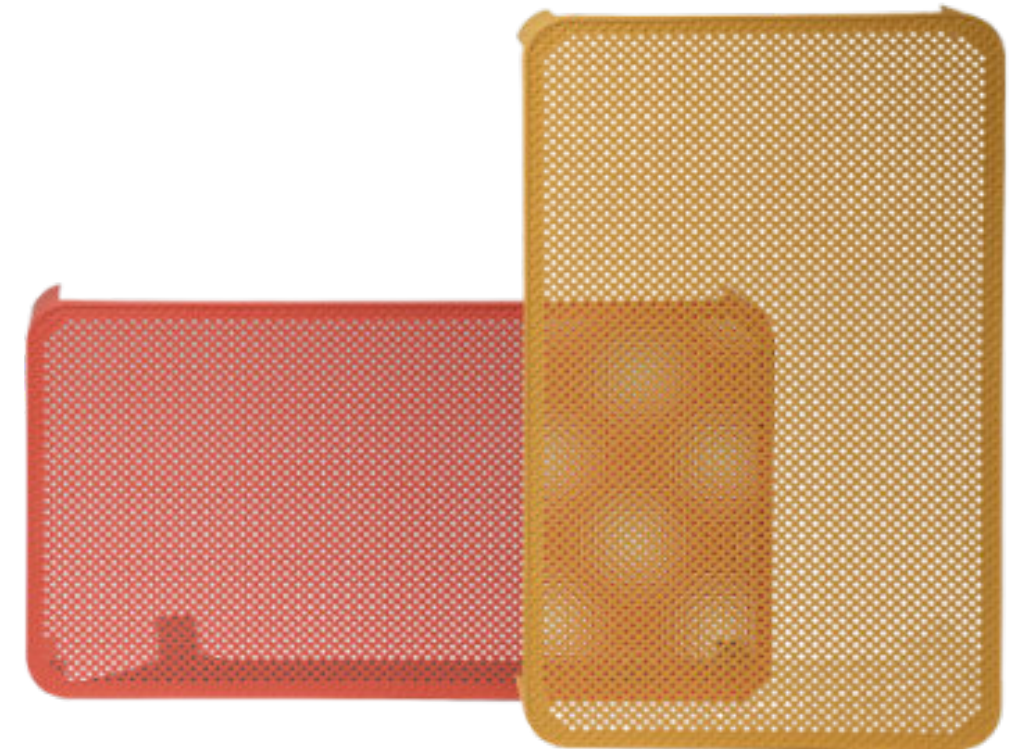
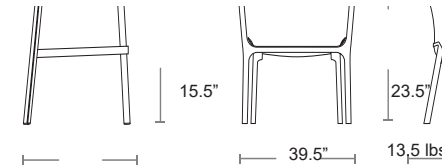

# LOUNGE TABLES

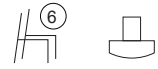







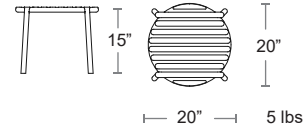

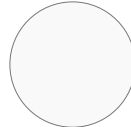
## Doga Side Table

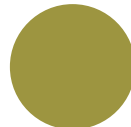
Uniformly colored fiberglass and polypropylene with UV additives, Matte finish, Non-slip feet, Recyclable resin.

LIST: \$130 EA.    SELL: \$85 EA.



-  BIANCO  
\*L-NAR-40042.00
-  ANTRACITE  
\*L-NAR-40042.02
-  AGAVE  
\*L-NAR-40042.16
-  PERA  
\*L-NAR-40042.18
-  MARSALA  
\*L-NAR-40042.21

- 
-  CAPPUCINO  
\*L-NAR-40042.14
-  MENTA  
\*L-NAR-40042.15
-  TABACCO  
\*L-NAR-40042.53



# LOUNGE TABLES





## Pop

Resin and fiberglass, UV protected, removeable shelf included

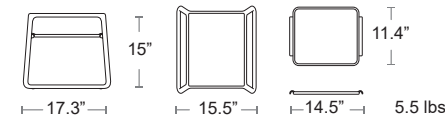
LIST: \$110 EA.    SELL: \$70 EA.

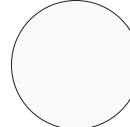

-  BIANCO  
\*L-NAR-40048.00
-  ANTRACITE  
\*L-NAR-40048.02
-  TORTORA  
\*L-NAR-40048.10



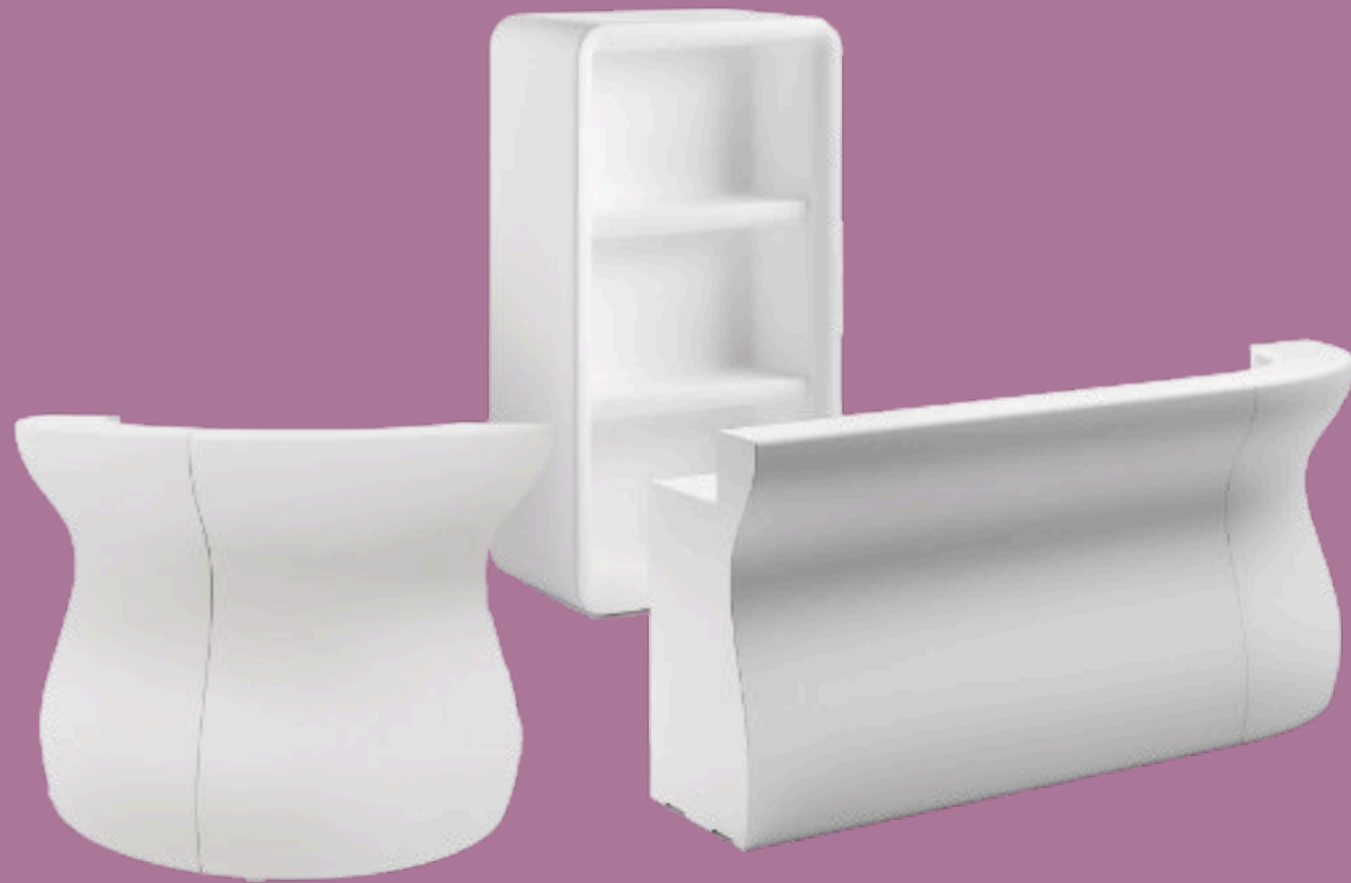

Bartolomeo Modular Bar Collection

Modular elements, easy to move, impact-resistant polyethylene construction  
Use alone or paired with other components to create what you need

Bartolomeo Bar Neutral

WITH 2 WHITE LIGHTS, 1 SHELF & WHEELS

LIST: \$4260 EA.    SELL: \$2770 EA.



\*CP-PL-6277-98

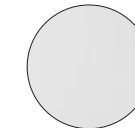
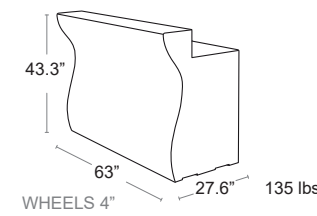

WHITE

Bartolomeo Bar Black

WITH 1 SHELF & WHEELS

LIST: \$3890 EA.    SELL: \$2530 EA.

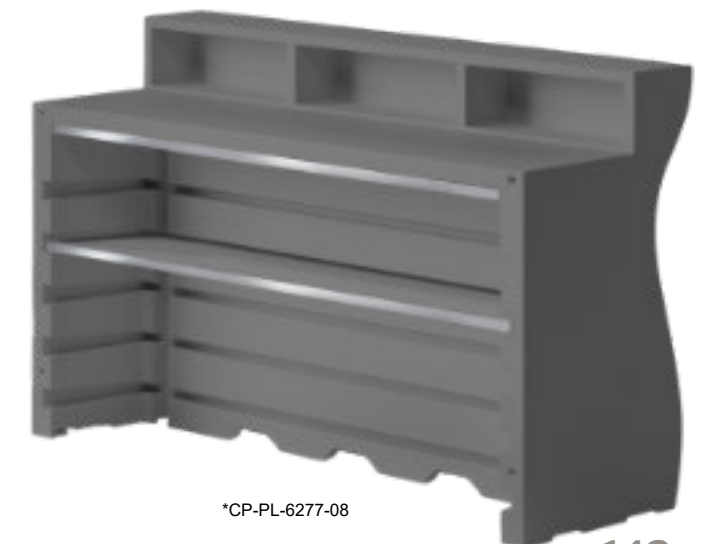
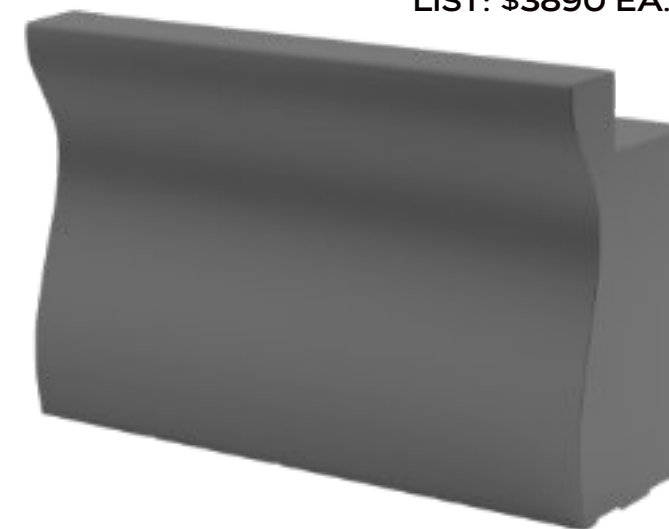

\*CP-PL-6277-08



BLACK



COMPLEMENTS



Bartolomeo Corner Neutral

WITH 1 WHITE LIGHT & WHEELS

LIST: \$1980 EA.    SELL: \$1290 EA.



\*CP-PL-6278-98

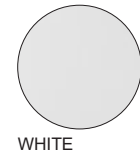

WHITE

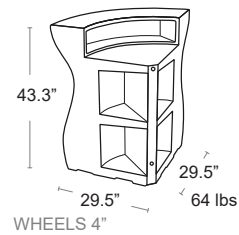

Double Corner



Bar & Corner



Bartolomeo Corner Black

WITH WHEELS

LIST: \$1800 EA.    SELL: \$1170 EA.



\*CP-PL-6278-08

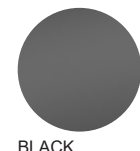

BLACK

COMPLEMENTS



Frozen Catering Counter

Catering counter and ice container with removable countertop. Impact resistant polyethylene construction, two compartments, lid fits either side, easy to move

Frozen Catering Counter Neutral

2 WHITE LIGHTS, HALF TOP & WHEELS

LIST: \$3200 EA.    SELL: \$2080 EA.

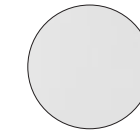

WHITE

\*CP-PL-6413-98

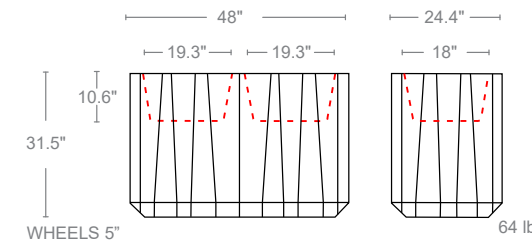

64 lbs

Frozen Catering Counter Black

WITH HALF TOP AND WHEELS

LIST: \$2800 EA.    SELL: \$1820 EA.



BLACK

\*CP-PL-6413-08

COMPLEMENTS



Bartolomeo  
Bar Display Neutral  
WITH 1 WHITE LIGHT  
**LIST: \$2300 EA.**  
**SELL: \$1500 EA.**

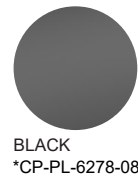
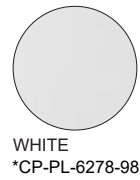
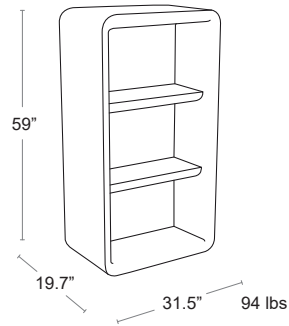

Bartolomeo  
Bar Display Black  
**LIST: \$2020 EA.**  
**SELL: \$1320 EA.**

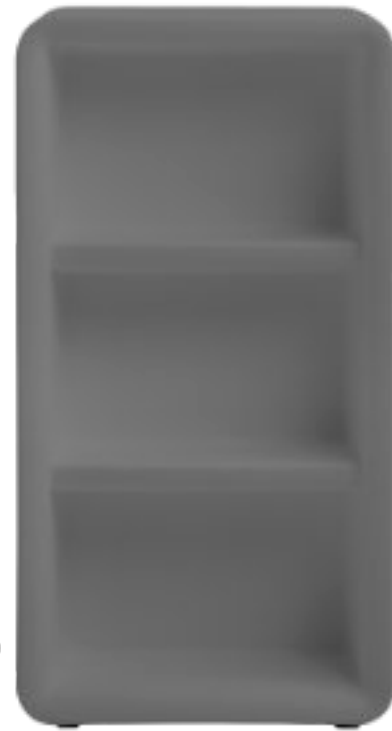

COMPLEMENTS



Jakarta Teak Collection

Solid Teak construction, Teak will develop a warm gray patina over time or it can be oiled annually to maintain the look of new wood, Teak requires virtually no maintenance and can be left on the patio during the summer months.

Bench

\*CP-BUM-TEAK-BENCHwBACK-6'

**LIST: \$1700 EA.**    **SELL: \$1105 EA.**

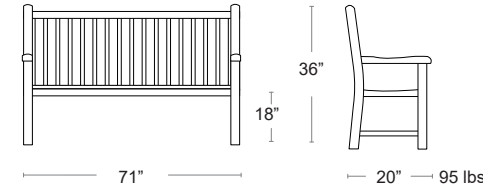

Backless Bench

\*CP-BUM-TEAK-BENCH-6'

**LIST: \$1120 EA.**    **SELL: \$730 EA.**

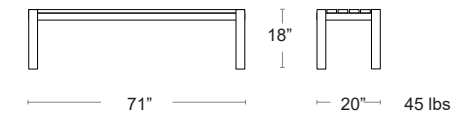

# COMPLEMENTS

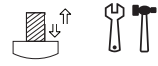

## Corner Post

\*CP-SSP-P223A-PLUS2-001



## End Post

\*CP-SSP-P223E-PLUS2-001



## Straight Post

\*CP-SSP-P223S-PLUS2-001



## 3' Panel

\*CP-SSP-PP3000-001



## 5' Panel

\*CP-SSP-PP5000-001

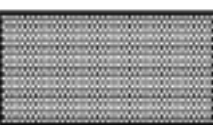

## 7' Panel

\*CP-SSP-PP7000-001



## Gate Set

\*CP-SSP-GS001-PLUS2-001

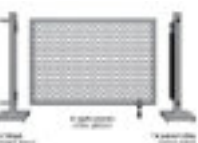

BLACK  
RAL9017

## Bum Fence

The panels and stands connect quickly and easily with spring push-buttons. Temporary or permanent, bases come with bolt hole knock-outs that can be removed and used to bolt the partitions into the ground. Panels are fabricated from heavy gauge perforated aluminum. Posts are heavy gauge aluminum and stainless steel bases, with leveling legs for uneven ground. All components are E-Plated Powder Coat and rust proofed.

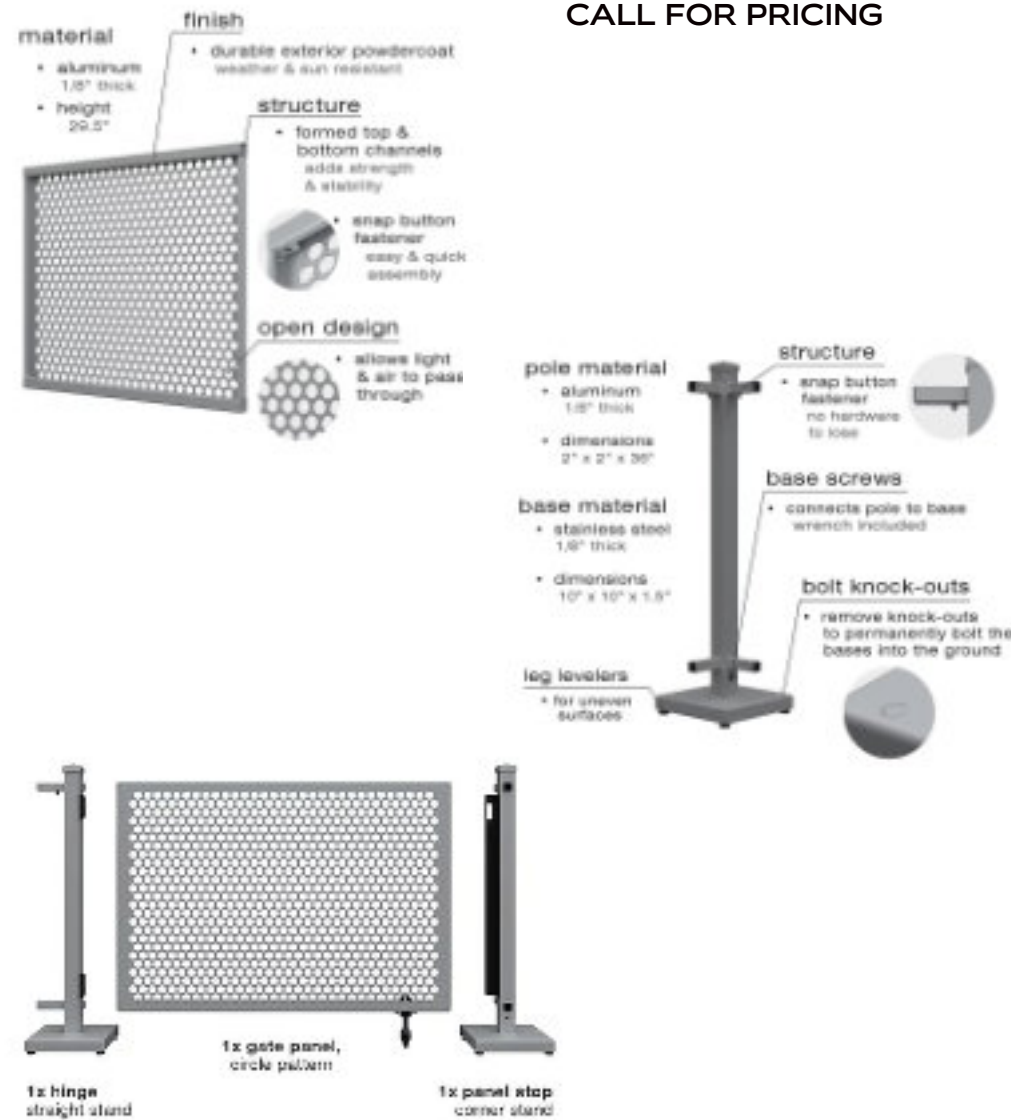

CALL FOR PRICING

# SHADE

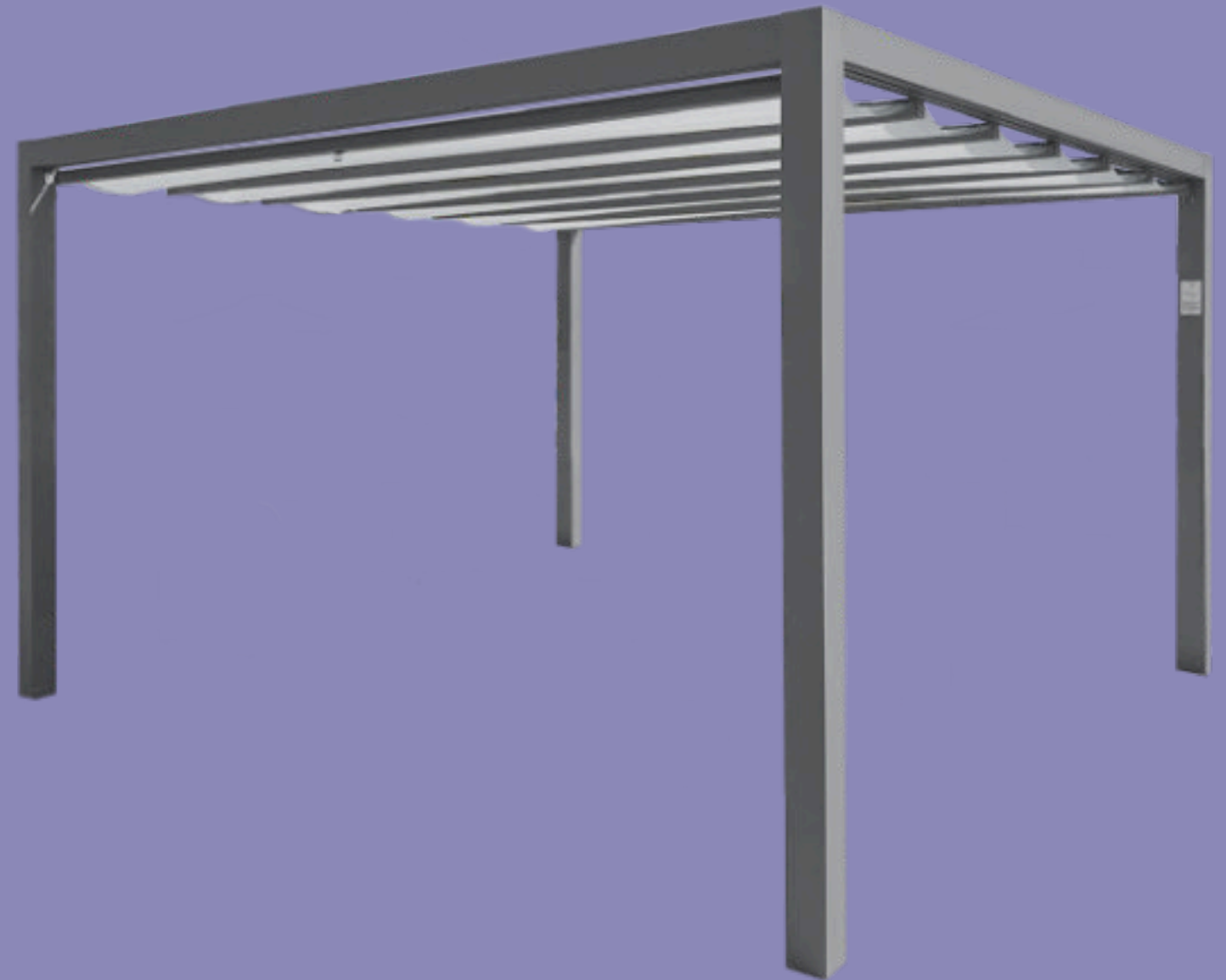

SPECIAL ORDER

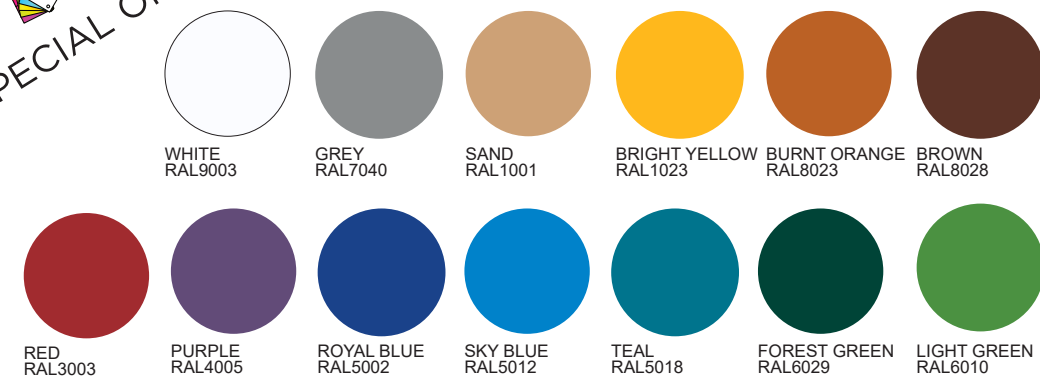

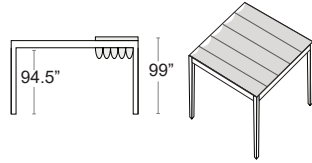

**Arcadia 20'x16'**

\*SH-GB-ARCADIA.20X16

**LIST: \$15500 EA.**

**SELL: \$10080 EA.**

**Arcadia 20'x13'**

\*SH-GB-ARCADIA.20X13

**LIST: \$14200 EA.**

**SELL: \$9230 EA.**

**Arcadia 20'x10'**

\*SH-GB-ARCADIA.20X10

**LIST: \$12800 EA.**

**SELL: \$8320 EA.**

**Arcadia 16'x13'**

\*SH-GB-ARCADIA.16X13

**LIST: \$12800 EA.**

**SELL: \$8320 EA.**

**Arcadia 16'x10'**

\*SH-GB-ARCADIA.16X10

**LIST: \$11400 EA.**

**SELL: \$7410 EA.**

**Arcadia 13x10'**

\*SH-GB-ARCADIA.13X10

**LIST: \$10600 EA.**

**SELL: \$6890 EA.**

**Arcadia 16'SQ**

\*SH-GB-ARCADIA.16SQ

**LIST: \$14000 EA.**

**SELL: \$9100 EA.**

**Arcadia 13'SQ**

\*SH-GB-ARCADIA.13SQ

**LIST: \$11700 EA.**

**SELL: \$7600 EA.**

**Arcadia 10'SQ**

\*SH-GB-ARCADIA.10SQ

**LIST: \$9700 EA.**

**SELL: \$6300 EA.**

**Arcadia**

ASK US ABOUT WALL MOUNT OPTIONS AND CUSTOM SIZES

**Arcadia Structure**

Aluminum structure, Stainless steel hardware  
 Cataphoresis-treated and coated with polyester powder,  
 Bolt-down hardware not included,  
 Attach multiple units together

**Arcadia Top Cover**

Ferrari Pre-Constraint 502, Heavy duty, M2 flame retardant PVC fabric,  
 Pre-stressed PVC coated fabric designed for external use

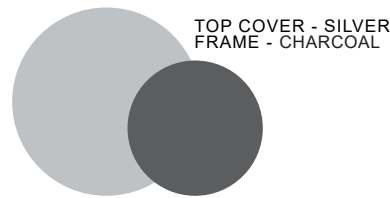

**Crank Roller Blind Mesh Soltis - Charcoal**

10'  
\*SH-GB-10SQ.RB

**LIST: \$1910 EA.**

**SELL: \$1250 EA.**

13'  
\*SH-GB-13SQ.RB

**LIST: \$2320 EA.**

**SELL: \$1510 EA.**

16'  
\*SH-GB-16SQ.RB

**LIST: \$2700 EA.**

**SELL: \$1755 EA.**

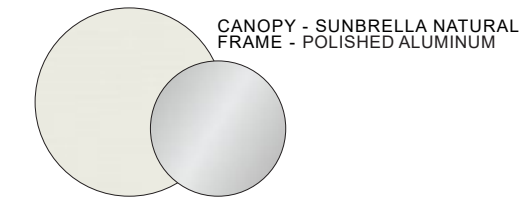
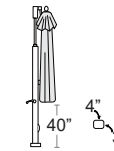
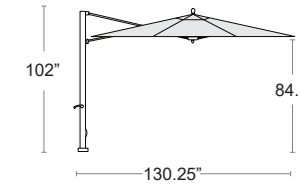

**Ocean Master MAX - Cantilever 10' Square**

Polished aluminum frame, Offset pole, Single vent, Market cut canopy,  
 Sunbrella Marine Grade fabric  
 Crank telescoping lift system, All parts are replaceable

**LIST: \$12880 EA.    SELL: \$8375 EA.**



OMX 10SQ CANTILEVER - NATURAL



### MAX G Umbrella Bases

MAX G Base fits with MAX collection umbrellas, Galvanized steel plates, Rounded corners, Each single plate is 1/2" Thick  
Stem comes with MAX umbrella, not base

#### MAX G Quad Stack

800 lbs

LIST: \$6260 EA. **SELL: \$4070 EA.**



\*SH-TU-GV36SQ X 4

#### MAX G Triple Stack

600 lbs

LIST: \$4900 EA. **SELL: \$3185 EA.**



\*SH-TU-GV36SQ X 3

#### MAX G Double Stack

400 lbs

LIST: \$3520 EA. **SELL: \$2290 EA.**



\*SH-TU-GV36SQ X 2

#### MAX On Ground Mount

To be used on existing cement surfaces  
9"x9" Stainless Steel, Mounting Hardware Included

LIST: \$1060 EA. **SELL: \$690 EA.**



MAXPLATE

#### MAX In Ground Mount

To be used on new cement only  
Stainless Steel

LIST: \$880 EA. **SELL: \$575 EA.**



MAX IGSM

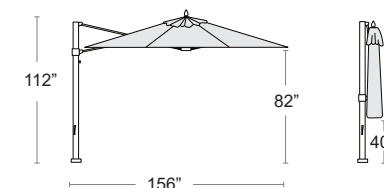

### Oasis - 13' Octagon Cantilever

Infinity Tilt & 360 Rotation, Crank system, Matte Silver Coated Aluminum Frame, Vent, Removable High Wind Stabilizer Bar, Black Polyester Cover Included  
Recacril 9 oz Marine Grade Solution Dyed Acrylic Fabric

LIST: \$7450 EA. **SELL: \$4845 EA.**



-  FRAME  
POLISHED ALUMINUM
-  DARK GREY  
\*SH-FF-880ECU-13'OCT-MS-DK.GREY
-  LAGOON  
\*SH-FF-880ECU-13'OCT-MS-LAGOON
-  VERMILLION RED  
\*SH-FF-880ECU-13'OCT-MS-RED
-  SEASHELL WHITE  
\*SH-FF-880ECU-13'OCT-MS-WHITE



### Oasis - Cantilever 10' Square

Recasens Recacril 9 oz Marine Grade Solution Dyed Acrylic Fabric, Wind stabilizer kit included, Extruded Aluminum, Stainless steel hardware, Crank lift, Infinity tilt with 360 degree rotation Protective Cover Included with Purchase

**LIST: \$7450 EA.    SELL: \$4845 EA.**

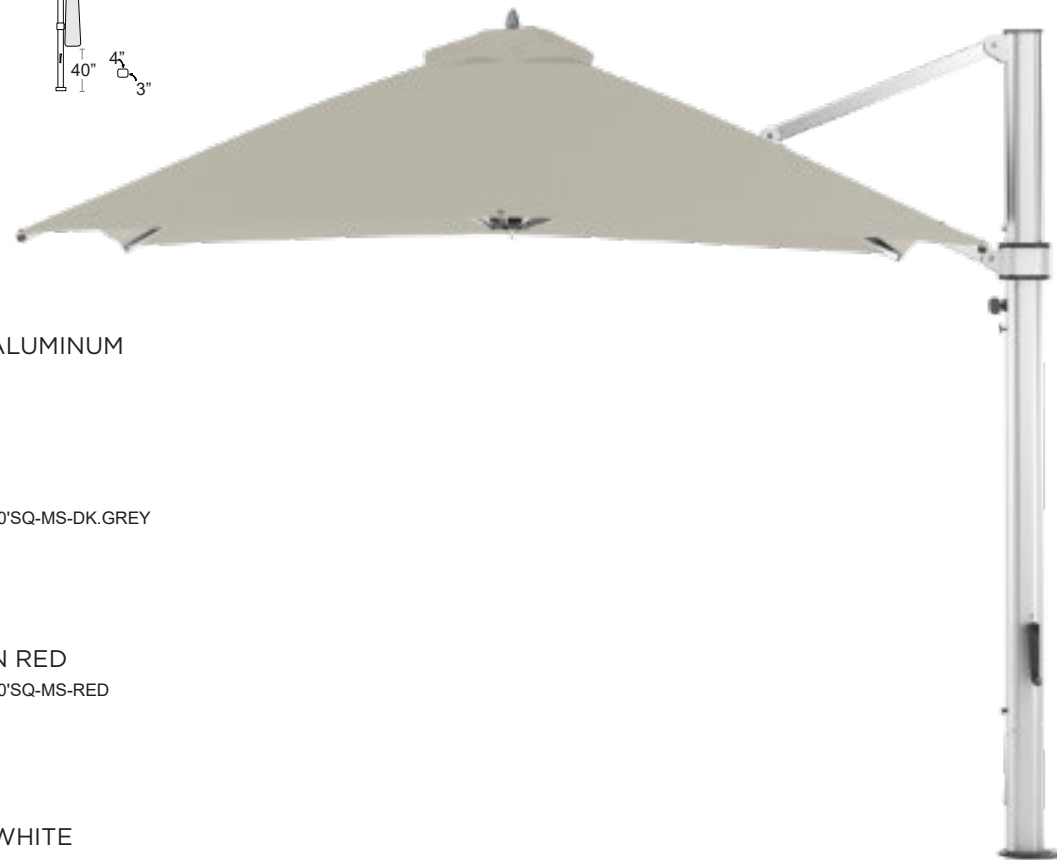
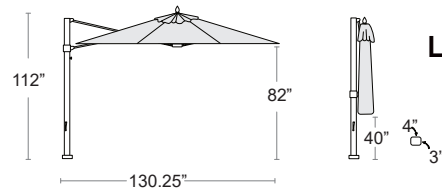

FRAME  
POLISHED ALUMINUM



DARK GREY  
\*SH-FF-883ECU-10'SQ-MS-DK.GREY



VERMILLION RED  
\*SH-FF-883ECU-10'SQ-MS-RED



SEASHELL WHITE  
\*SH-FF-883ECU-10'SQ-MS-WHITE



LAGOON  
\*SH-FF-883ECU-10'SQ-MS-LAGOON

### Oasis On Ground Mount

To be used on existing concrete or wood surfaces  
Use with Oasis Cantilever  
12.5" Diameter 12 lbs

**LIST: \$280 EA.  
SELL: \$180 EA.**



BLACK  
\*SH-FF-ECU-DP-BK

### Oasis Triple Stack with Wheels

Galvanized steel plate, Silver Dacromet coated, Triple Stacked, Hardware included, 600 LBS

**LIST: \$6320 EA.  
SELL: \$4110 EA.**



\*SH-FF-OASIS-36G-SQx3+W

### Oasis In Ground Stem

To be used on new cement only  
Galvanized Steel  
Use with Oasis Cantilever

**LIST: \$370 EA.  
SELL: \$240 EA.**



\*SH-FF-ECU-IG



### Bay Master 8' & 6.5' Square

Polished aluminum frame, Center pole and stem, Single vent, Market cut canopy, Sunbrella Furniture Grade fabric  
Manual lift with easy grip handle, All parts are replaceable



### Bay Master 8 SQ

\*SH-BM8.0SQ + COLOR

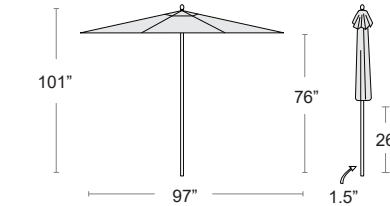

**LIST: \$1800 EA.  
SELL: \$1170 EA.**



### Bay Master 6.5'SQ

\*SH-TU-BM6.5SQ + COLOR

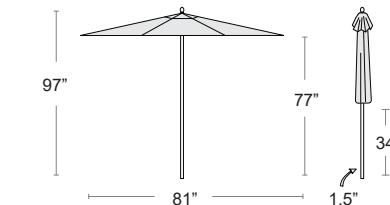

**LIST: \$1350 EA.  
SELL: \$875 EA.**

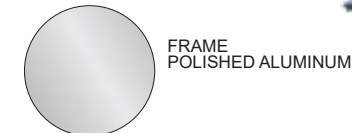

FRAME  
POLISHED ALUMINUM



GRANITE



JOCKEY RED

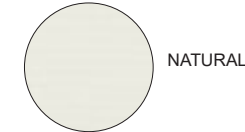

NATURAL

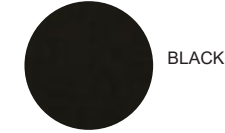

BLACK



TUSCAN



MACAW

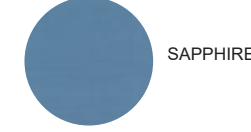

SAPPHIRE



COAL



G Bases

G base will fit with all Tuuci umbrellas with a 1.5" thick center pole, Galvanized steel plates, Rounded corners  
Each plate is 1/2" Thick, Deck mount and hardware included,  
Lock hole available on request

30" Square - 140 lbs

\*SH-TU-GV30SQ

LIST: \$1200 EA. SELL: \$780 EA.

24" Square - 90 lbs

\*SH-TU-GV24SQ

LIST: \$880 EA. SELL: \$575 EA.

30" Round - 105 lbs

\*SH-TU-GV30RND

LIST: \$1050 EA. SELL: \$685 EA.

24" Round - 75 lbs

\*SH-TU-GV24RND

LIST: \$820 EA. SELL: \$535 EA.



In Ground Flush Mount

Stainless steel ground flush mount, Comes with aluminum extension pole  
Fits 1.5" thick center pole umbrellas, Mounting hardware included, 6 lbs  
Lock hole available on request

LIST: \$700 EA. SELL: \$455 EA.



\*SH-TU-FLUSHMT



Deck Mount

Stainless steel Fits 1.5" thick center pole umbrellas,  
Star knob locking system, 4 lbs  
Lock hole available on request

LIST: \$300 EA. SELL: \$195 EA.



\*SH-TU-DECKMNT



Aluma Crete

Aluminum shell filled with concrete, E-Plated Powder Coat silver, Stainless steel security sleeve and hardware, Fits up to 1.5" thick center pole umbrellas  
Lock hole available on request

28" Round with Wheels- 150 lbs

\*SH-TU-ACF150W

LIST: \$1120 EA. SELL: \$730 EA.

24" Round with Wheels - 95 lbs

\*SH-TU-ACF95W

LIST: \$920 EA. SELL: \$600 EA.

28" Round - 150 lbs

\*SH-TU-ACF150

LIST: \$840 EA. SELL: \$545 EA.

24" Round - 95 lbs

\*SH-TU-ACF95

LIST: \$630 EA. SELL: \$410 EA.

20" Round - 65 lbs

\*SH-TU-ACF65

LIST: \$560 EA. SELL: \$365 EA.



Umbrella Locks

LIST: \$20 EA. SELL: \$13 EA.

Cable Lock

14" Cable Lock  
\*SH-TU-CABLE LOCK



Master Lock

\*SH-TU-LOCK





### Oasis 6' x 9' Rectangle

Recasens Recacril 9 oz Marine Grade Solution Dyed Acrylic Fabric, Brushed aluminum frame with single wind vent, 2 piece center pole, Stainless steel hardware, Manual lift with pin

**LIST: \$1400 EA.    SELL: \$910 EA.**

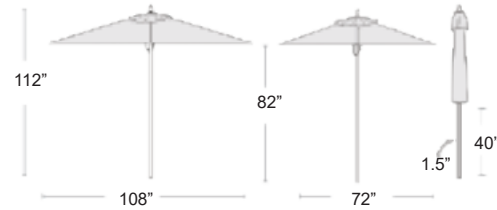

-  DARK GREY  
\*SH-FF-OASIS-6'x9'-DARK.GREY
-  VERMILION  
\*SH-FF-OASIS-6'x9'-RED
-  SEASHELL  
\*SH-FF-OASIS-6'x9'-WHITE



**SPECIAL ORDER**

#### CUSTOM COLOR FABRIC

\*SH-FF-OASIS-6' X 9'-FRAME + FABRIC CODE  
info@bumoutdoor.ca for options

**LIST: \$1960 EA.    SELL: \$1275 EA.**



### Oasis 7.5' Square

Recasens Recacril 9 oz Marine Grade Solution Dyed Acrylic Fabric, Brushed aluminum frame with single wind vent, 2 piece center pole, Stainless steel hardware, Manual lift with pin

**LIST: \$1260 EA.    SELL: \$820 EA.**

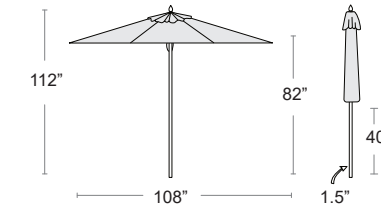

-  FRAME  
BRUSHED ALUMINUM
-  DENIM BLUE  
\*SH-FF-OASIS-7.5'SQ-BLUE
-  DARK GREY  
\*SH-FF-OASIS-7.5'SQ-DARK.GREY
-  VERMILION  
\*SH-FF-OASIS-7.5'SQ-RED
-  TITANIUM  
\*SH-FF-OASIS-7.5'SQ-TITAN.GREY
-  SEASHELL  
\*SH-FF-OASIS-7.5'SQ-WHITE



**SPECIAL ORDER**

#### CUSTOM COLOR FABRIC

\*SH-FF-OASIS-7.5'SQ-FRAME + COLOR CODE  
info@bumoutdoor.ca for options

**LIST: \$1750 EA.    SELL: \$1140 EA.**





### Oasis 9' Octagon

Recasens Recacril 9 oz Marine Grade Solution Dyed Acrylic Fabric, Brushed aluminum frame with single wind vent, 2 piece center pole, Stainless steel hardware, Manual lift with pin

**LIST: \$1210 EA.    SELL: \$785 EA.**

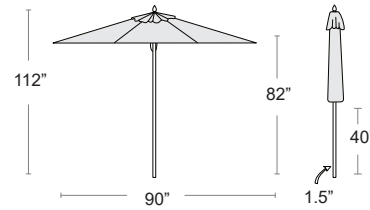

-  FRAME BRUSHED ALUMINUM
-  DENIM BLUE  
\*SH-FF-OASIS-9'OCT-BLUE
-  DARK GREY  
\*SH-FF-OASIS-9'OCT-DARK.GREY
-  VERMILION  
\*SH-FF-OASIS-9'OCT-RED
-  TITANIUM  
\*SH-FF-OASIS-9'OCT-TITAN.GREY
-  SEASHELL  
\*SH-FF-OASIS-9'OCT-WHITE



 SPECIAL ORDER

**CUSTOM COLOR FABRIC**  
\*SH-FF-OASIS-9'OCT-FRAME + CCOLORCODE  
info@bumoutdoor.ca for options  
**LIST: \$1720 EA.    SELL: \$1120 EA.**



### Aluminum Concrete

Aluminum E-Plated Powder Coat Shell Filled with Concrete - Wheels - Brushed Silver - 18" Stem - 1.5" Diameter - 2 Locking Points

#### 150A Round with Wheels - 150 lbs

\*SH-FF-150A/18ST2-MS

**LIST: \$1950 EA.    SELL: \$1265 EA.**

#### 100A Round with Wheels - 100 lbs

\*SH-FF-100A/18ST-MS

**LIST: \$1250 EA.    SELL: \$815 EA.**



### Bum Galvanized Steel Bases

Galvanized Steel Base - 1/2" Thick - 18" High Stem - 2 Locking Points

#### 30" Round - 100 lbs

\*SH-FF-30G/18ST-GS

**LIST: \$1800 EA.    SELL: \$1170 EA.**

#### 24" Round - 70 lbs

\*SH-FF-24G/18ST-GS

**LIST: \$1450 EA.    SELL: \$945 EA.**

#### 24" Square - 100 lbs

\*SH-FF-24G-SQ/18ST-GS

**LIST: \$1640 EA.    SELL: \$1065 EA.**

#### 20" Square - 70 lbs

\*SH-FF-20G-SQ/18ST-GS

**LIST: \$1440 EA.    SELL: \$935 EA.**





### Oasis 24" SQ Steel Base with Wheels

E-Plated Powder Coat finish, Silver Mist, 2 stationary wheels, 16" threaded stem  
Fits 1.5" Umbrella pole, 2 locking points, 4 holes to bolt down if required

LIST: \$800 EA.    SELL: **\$520 EA.**

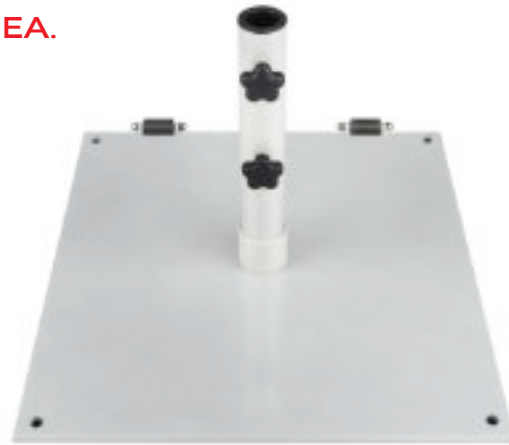

SILVER MIST  
\*SH-FF-OASIS-75S-SM



### Oasis 80 Lb Coated Concrete Base

Resin coated concrete base, 2 locking points,  
bottom ring can be bolted to a surface

LIST: \$390 EA.    SELL: **\$255 EA.**



MATTE SILVER  
\*SH-FF-OASIS-23-MS

### Additional 35 Lb Ring

LIST: \$240 EA.    SELL: **\$155 EA.**



MATTE SILVER  
\*SH-FF-OASIS-23-R



### Oasis 50 Lb Coated Concrete Base

Resin coated concrete base

**USE WITH TABLE ONLY NOT FREE STANDING**

LIST: \$280 EA.    SELL: **\$185 EA.**



MATTE SILVER  
\*SH-FF-50C-MS



# PLANTERS



## Hedge Planter Set

E-Coated Steel Frame withstands harsh outdoor weather, Great for privacy, Outdoor 3-year warranty, Strong wind resistance  
 Manufactured to ISO 9001 standards, SGS-certified artificial foliage  
 UV protection, Durable, movable, and reusable  
 Wheels available.

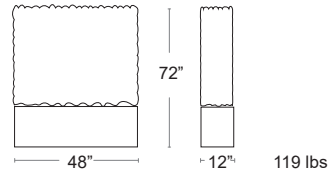

## Hedge Planter Set 6'

**LIST: \$2840 EA.**  
**SELL: \$1845 EA.**

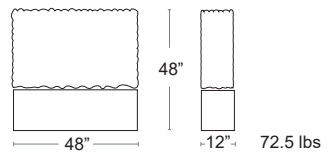

**LIST: \$70 EA.**  
**SELL: \$35 EA.**



\*P-BUM-HEDGE WHEELS 4PK

## Hedge Planter Set 4'

**LIST: \$2000 EA.**  
**SELL: \$1300 EA.**

## Hedge Connectors

Connects two planters together for extra stability

**NET: \$5 EA.**



\*P-BUM-HEDGE CONNECTOR



\*P-BUM-HEDGE 6'



\*P-BUM-HEDGE 4'

# PLANTERS



## Bamboo Artificial Tree

Bamboo artificial tree with green leaves. Realistic detail integrated injection process leaves and stems are one piece.  
 Manufactured to ISO 9001 standards, SGS-certified artificial foliage  
 UV protection, Durable, movable, and reusable



## Bamboo Tree 80"

\*P-BUM-BAMBOO-80"

**LIST: \$260 EA.**  
**SELL: \$170 EA.**

## Bamboo Tree 60"

\*P-BUM-BAMBOO-60"

**LIST: \$160 EA.**  
**SELL: \$105 EA.**



# PLANTERS



## Kabin Planters

LLDPE (linear low-density polyethylene) achieved by rotational molding. UV protection. 100% recyclable, High degree of mechanical strength and resistance to impacts,

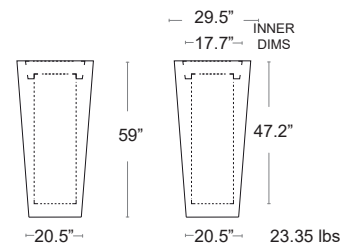

### Kabin Extra

**LIST: \$2160 EA.**  
**SELL: \$900 EA.**

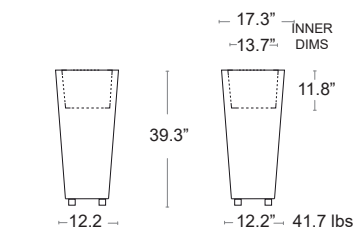
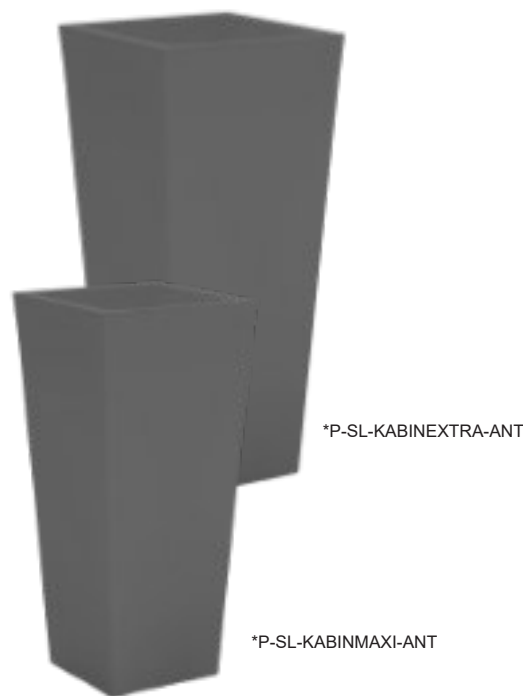

### Kabin Maxi

**LIST: \$920 EA.**  
**SELL: \$600 EA.**



\*P-SL-KABINMAXI-ANT

# PLANTERS



## Neoclassic

LLDPE (linear low-density polyethylene) achieved by rotational molding. UV protection. 100% recyclable, High degree of mechanical strength and resistance to impacts, Textured finish

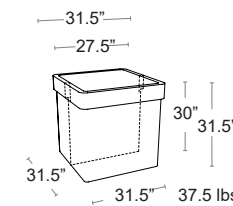

### Neoclassic Quadro

**LIST: \$1100 EA.**  
**SELL: \$715 EA.**



\*P-SL-NEOCLASSIC-788-ANT

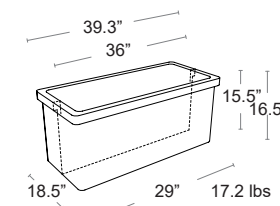

### Neoclassic Cassetta

**LIST: \$480 EA.**  
**SELL: \$315 EA.**



\*P-SL-NEOCLASSIC-710-ANT



## Lluna Planters

LLDPE (linear low-density polyethylene) achieved by rotational molding. UV protection. 100% recyclable, High degree of mechanical strength and resistance to impacts, Lacquered finish, Resistant to temperatures, - 35°C - 80°C.

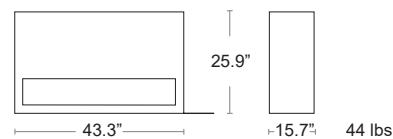

### Lluna 110

**LIST: \$1380 EA.**  
**SELL: \$900 EA.**

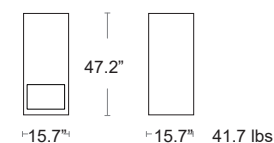

### Lluna Nova

**LIST: \$1190 EA.**  
**SELL: \$775 EA.**



## Fence

LLDPE (linear low-density polyethylene) achieved by rotational molding. UV protection. 100% recyclable, With galvanized steel reinforcement High degree of mechanical strength and resistance to impacts, Matte finish Resistant to temperatures, - 35°C - 80°C.

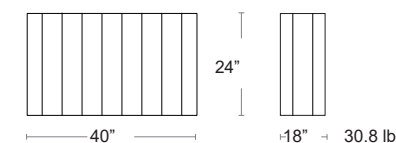

### Fence Large

**LIST: \$1010 EA.**  
**SELL: \$660 EA.**



\*P-SL-715-ANT

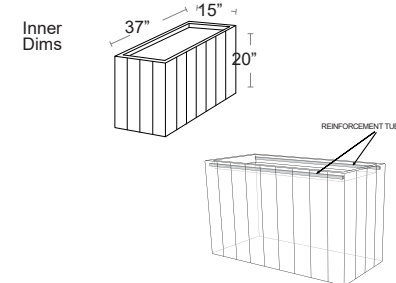

### Fence Small

**LIST: \$380 EA.**  
**SELL: \$250 EA.**



\*P-SL-715 SMALL-ANT

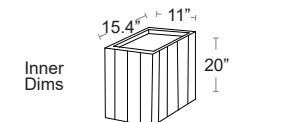

# PLANTERS



## Newpot Planters

Rotational molded resin planter, UV Protected, Can handle -40C to +40C  
Suitable for both outdoor and indoor use.

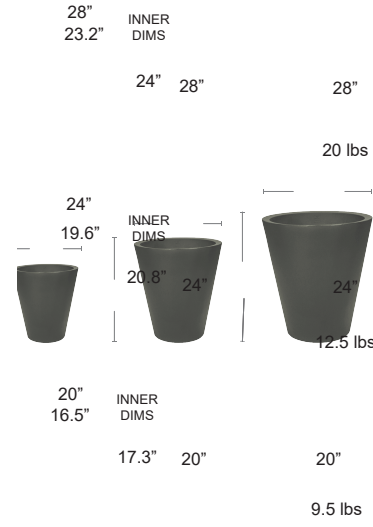

### Newpot 70

\*P-SL-NEWPOT70 + COLOR

**LIST: \$780 EA.**  
**SELL: \$510 EA.**

### Newpot 60

\*P-SL-NEWPOT60 + COLOR

**LIST: \$580 EA.**  
**SELL: \$380 EA.**

### Newpot 50

\*P-SL-NEWPOT50 + COLOR

**LIST: \$440 EA.**  
**SELL: \$285 EA.**

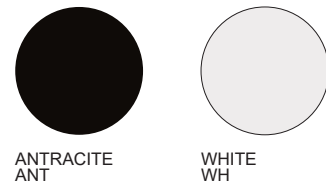

# PLANTERS



## Sipario Self Watering Planter System

Modular Partition wall system, Polypropylene resin, Self watering planter,  
UV Protected  
GREEN GOOD DESIGN AWARD 2021

### Sipario 3

\*P-Nar-40395 + COLOR

**LIST: \$600 EA.**  
**SELL: \$390 EA.**

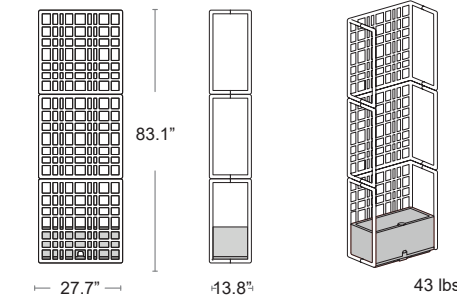

### Sipario 2

\*P-Nar-40394 + COLOR

**LIST: \$450 EA.**  
**SELL: \$295 EA.**

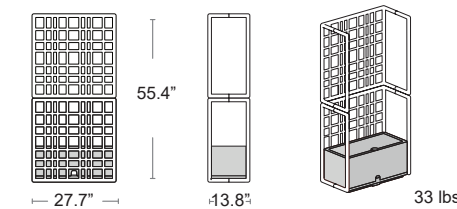

## Torre 755

LLDPE (linear low-density polyethylene) achieved by rotational molding. UV protection.  
100% recyclable. High degree of mechanical strength and resistance to impacts,  
Lacquered finish Resistant to temperatures, minus 35°C plus 80°C.

**LIST: \$740 EA.**      **SELL: \$480 EA.**

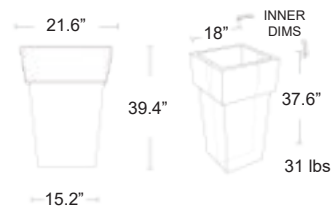

# PLANTERS



## Vaso Rettangolare

LLDPE (linear low-density polyethylene) achieved by rotational molding. UV protection. 100% recyclable. High degree of mechanical strength and resistance to impacts, Resistant to temperatures, minus 35°C plus 80°C.

**LIST: \$540 EA.    SELL: \$350 EA.**

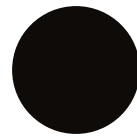
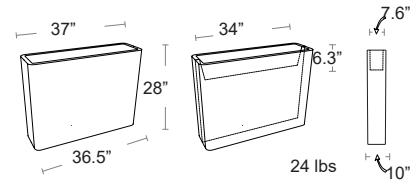

ANTRACITE  
\*P-SL-722-ANT



## Cubotti

LLDPE (linear low-density polyethylene) achieved by rotational molding. UV protection. 100% recyclable. High degree of mechanical strength and resistance to impacts, Resistant to temperatures, minus 35°C plus 80°C.

**LIST: \$460 EA.    SELL: \$300 EA.**

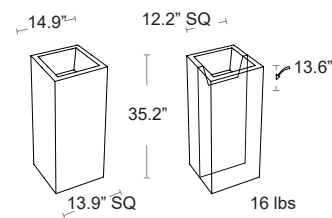

ANTRACITE  
\*P-SL-722-ANT

# FLAME





### Moderne Propane Commercial Fire Table

Fiberglass reinforced cast concrete, Stainless steel burner, Electronic Ignition  
60,000 BTU professional burner system,  
Auto flame out for safety, Includes levelers for stability  
Includes Burner Cover, Glass Windscreen & Propane Tank Cover

**LIST: \$8200 EA.    SELL: \$5330 EA.**

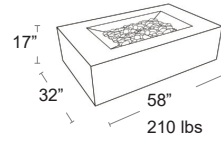

### Moderne Natural Gas Commercial Fire Table

Fiberglass reinforced cast concrete, Stainless steel burner, Electronic Ignition  
60,000 BTU professional burner system,  
Auto flame out for safety, Includes levelers for stability

**LIST: \$7600 EA.    SELL: \$4940 EA.**

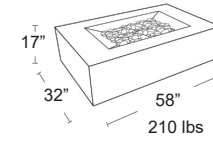

### Propane Tank Cover/Side Table or Seat

Fiberglass reinforced cast concrete

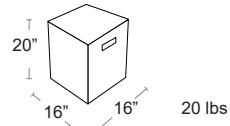

### Tempered Glass Wind Screen 38" x 24"



### Tempered Glass Wind Screen 38" x 24"



### Aluminum Burner Cover



### Aluminum Burner Cover





Natural Gas Conversion Kit

\*F-NP-S85004  
SOLD SEPARATELY FOR ALL MODELS

LIST: \$310 EA.  
SELL: \$200 EA.

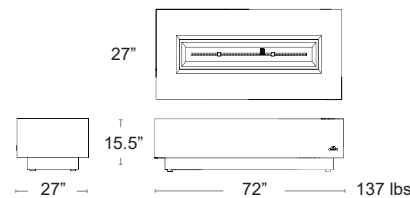

Nexus Flame Table 72"

Cast aluminum construction that looks like formed concrete. Premium stainless steel burner with lava rock media, Cover included, 53,000 BTU's SOLD AS A COMPLETE SET 10' propane hose, All weather cover

LIST: \$5250 EA. SELL: \$3400 EA.



NEXUS.72 SET

Nexus Flame Table 56"

Cast aluminum construction that looks like formed concrete. Premium stainless steel burner with lava rock media, Cover included, 53,000 BTU's SOLD AS A COMPLETE SET 10' propane hose, All weather cover

LIST: \$4055 EA. SELL: \$2635 EA.

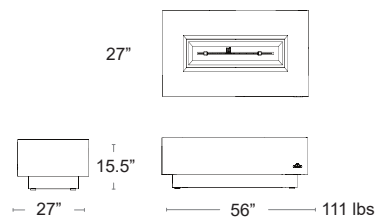

NEXUS.56 SET

Nexus Flame Table 36"

Cast aluminum construction that looks like formed concrete. Premium stainless steel burner with lava rock media, Cover included, 53,000 BTU's SOLD AS A COMPLETE SET 10' propane hose, All weather cover

LIST: \$3080 EA. SELL: \$2000 EA.

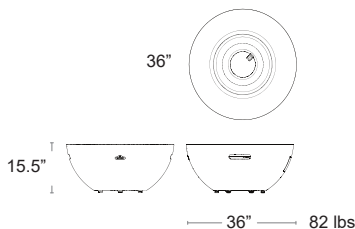

NEXUS.36 SET



St Tropez

Rectangular and Square Linear Design Patio Flame Tables All aluminum construction, Propane tank can be hidden inside the table Stylish glass ember bed, Easy start electronic ignition, 60,000 BTU of Heat Thermo-couple valve shuts off gas supply if flame is extinguished Stainless steel 10"x 30" pan burner Comes complete with lid for burner and natural gas conversion kit COVER AND GLASS WINDSCREEN INCLUDED WITH TABLE

LIST: \$3700 EA. SELL: \$2400 EA.



RECTANGLE RUSTIC BRONZE ST. TROPEZ RECT. FLAME SET 104 lbs without cylinder

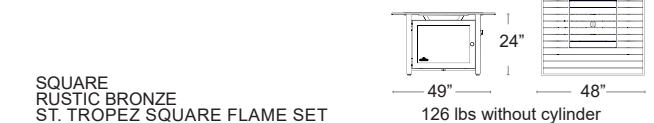

SQUARE RUSTIC BRONZE ST. TROPEZ SQUARE FLAME SET 126 lbs without cylinder



Hampton

Rectangular and Square Linear Design Patio Flame Tables All aluminum construction, Propane tank can be hidden inside the table Stylish glass ember bed, Easy start electronic ignition, 40,000 BTU of Heat Thermo-couple valve shuts off gas supply if flame is extinguished Stainless steel pan burner Comes complete with lid for burner and natural gas conversion kit COVER AND GLASS WINDSCREEN INCLUDED WITH TABLE

LIST: \$3400 EA. SELL: \$2200 EA.

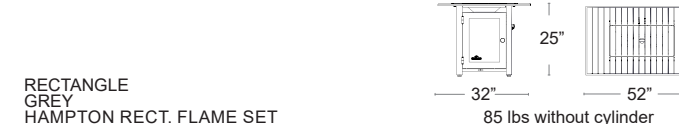

RECTANGLE GREY HAMPTON RECT. FLAME SET 85 lbs without cylinder

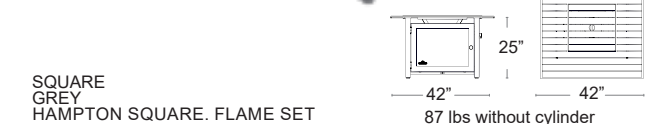

SQUARE GREY HAMPTON SQUARE FLAME SET 87 lbs without cylinder





### Pyramid Heater

Quartz Tube Tower Heater made to withstand all commercial applications, 42,000 BTUH  
 Heat range of up to 10' diameter,  
 Piezo Push -button ignition  
 Variable gas control valve,  
 Standard 20 Lb and 30 Lb propane tank compatible  
 304 stainless steel body, wire mesh and hardware  
 Fused tempered quartz glass,  
 Aluminum Frame  
 Larger steel reflector,  
 Flame height adjustment control knob  
 Wheels designed for easy mobility  
 Propane tank not included

**LIST: \$970 EA.     SELL: \$630 EA.**

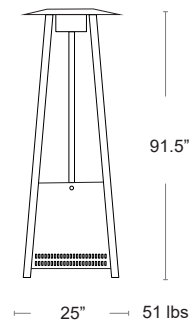

\*F-BUM-FSD-C-SS



### Comfort Plus Infrared Heater

Provides up to 64 square feet of radiant warmth ,  
 90% efficiency in converting energy into directional, virtually wind-proof heat.  
 Weatherproof, stainless steel construction  
 Operate safely in all weather conditions, cETLus certified

SUITABLE FOR WALL OR CEILING MOUNTING,  
 REMOTE CONTROL INCLUDED WITH ALL MODELS  
 BATTERIES NOT INCLUDED

#### Aura 3000W - 208/240V Wall/Ceiling Mount

**LIST: \$1560 EA.     SELL: \$1015 EA.**

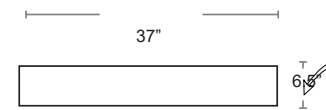

BLACK  
 \*F-ICP-CF30240B

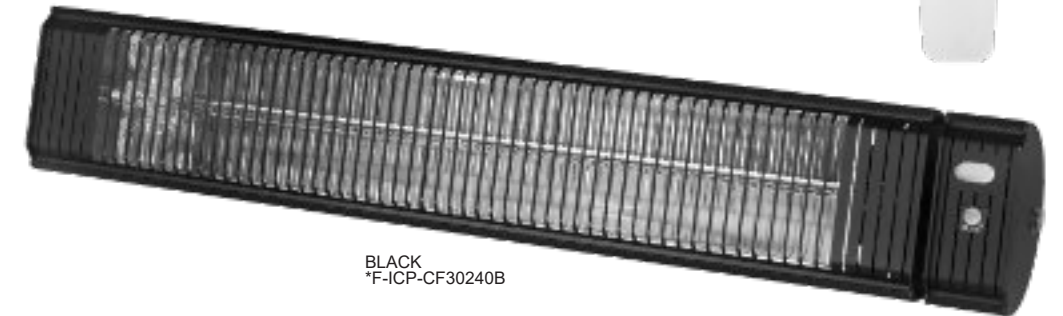

### Commercial Tube Heater

Heavy duty stainless steel body,  
 Weather resistant,  
 Anti-Tilt Switch  
 Auto Shut Off  
 Holds standard 20lb propane tank  
 10+ Hours of burn time on High  
 Wheels, Hose & Regulator included,  
 ETL Certified  
 Easy on/off tank access  
 High output and fuel efficient burner  
 44,382 BTU  
 Propane tank not included

**LIST: \$910 EA.     SELL: \$590 EA.**

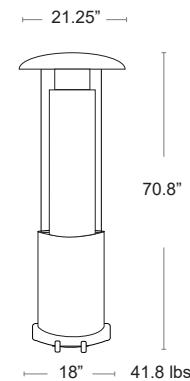

\*F-BUM-FSD-E-SS

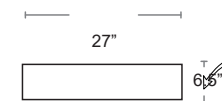

BLACK  
 \*F-ICP-CF15120B

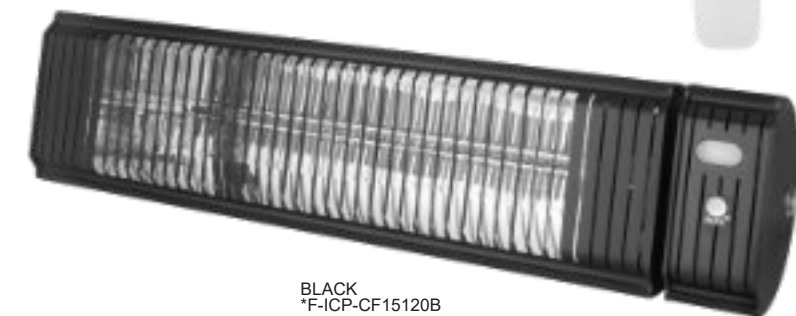



Resin Finishes

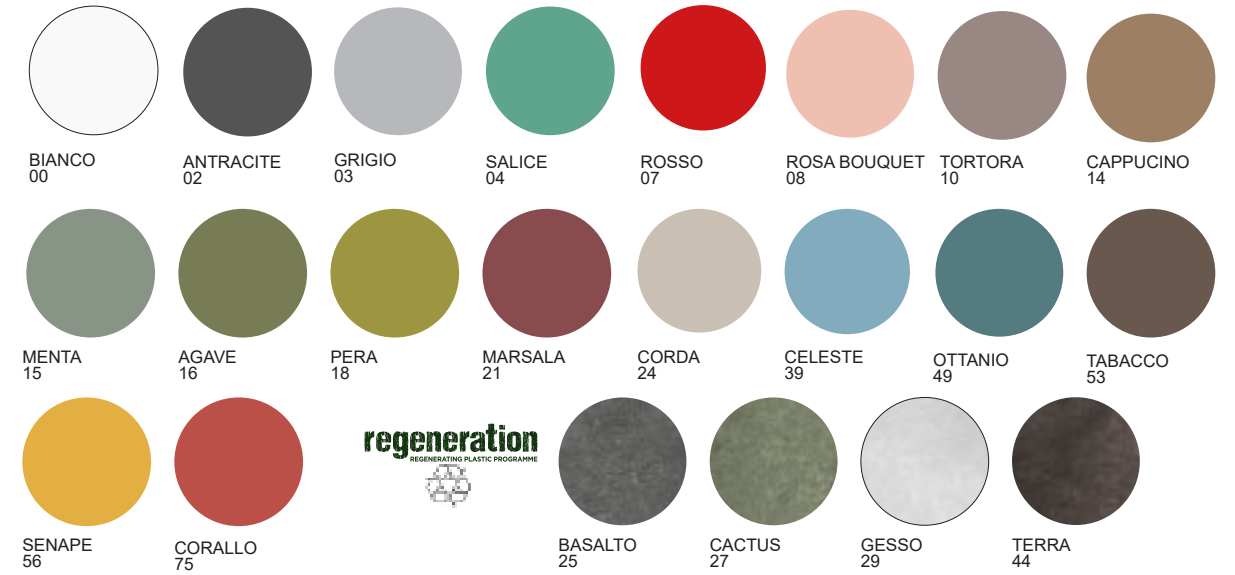
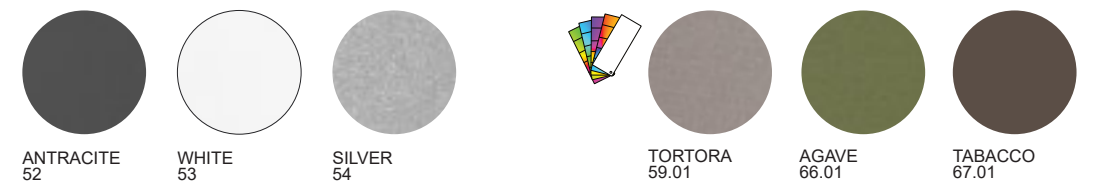
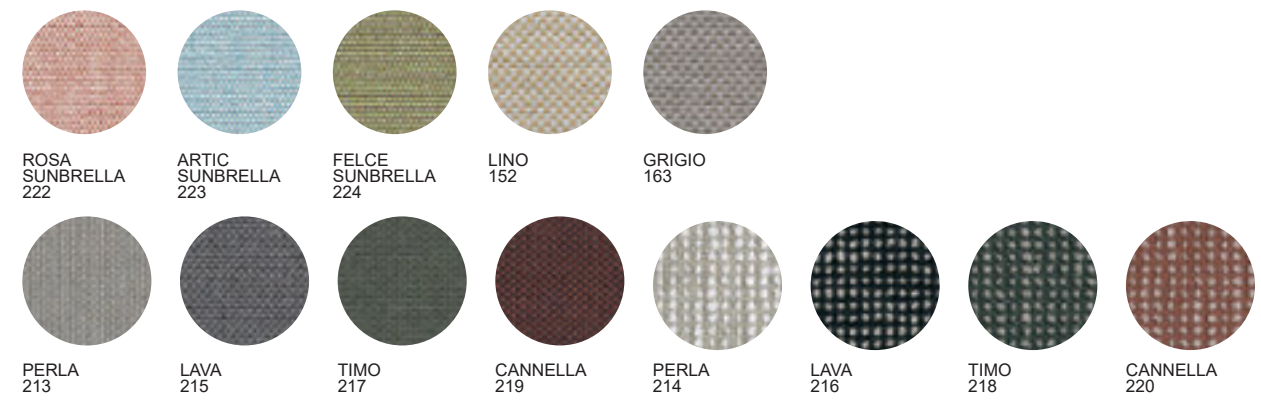

Table Bases



Nardi Cushions



Resin Finishes - Made in Canada

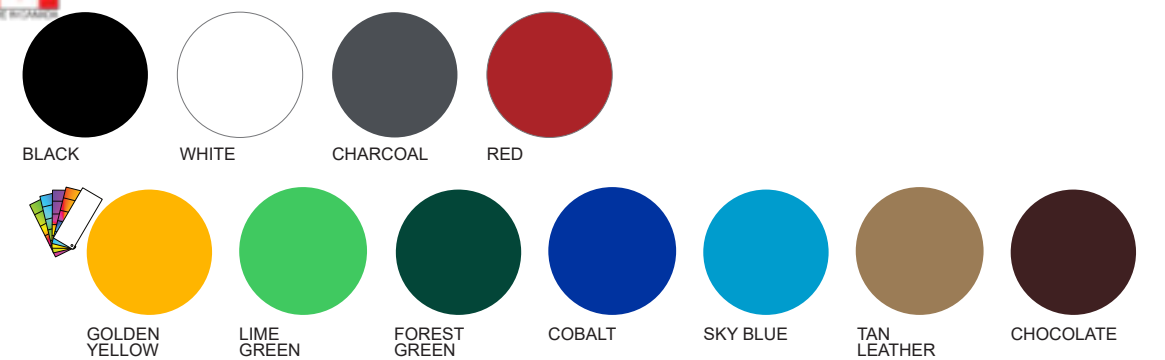

# SWATCHES

## Resin Finishes

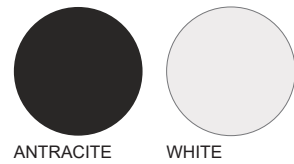

ANTRACITE WHITE

## Cushions and Toss Pillows

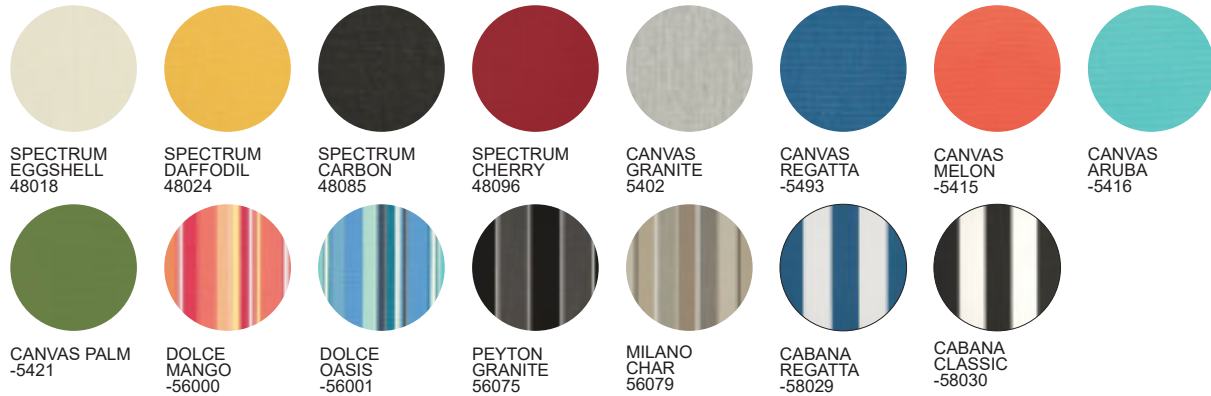

SPECTRUM EGGHELL 48018 SPECTRUM DAFFODIL 48024 SPECTRUM CARBON 48085 SPECTRUM CHERRY 48096 CANVAS GRANITE 5402 CANVAS REGATTA -5493 CANVAS MELON -5415 CANVAS ARUBA -5416  
CANVAS PALM -5421 DOLCE MANGO -56000 DOLCE OASIS -56001 PEYTON GRANITE 56075 MILANO CHAR 56079 CABANA REGATTA -58029 CABANA CLASSIC -58030

## Marco Finishes



GREY TEAK BATYLINE VIRO WICKER

## Marco Frames



SILVER ANTRACITE

## Parisian

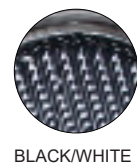

BLACK/WHITE

## Lounge Cushions

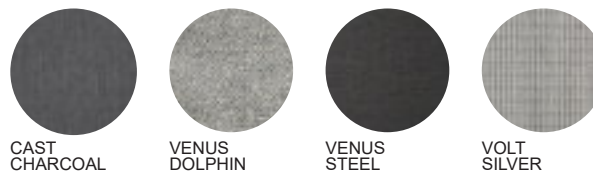

CAST CHARCOAL VENUS DOLPHIN VENUS STEEL VOLT SILVER

## Lounge Frame Finish



SKYLINE ALL WEATHER WICKER URBAN BLACK CITY VIEW ANTRACITE

## Tabletop Finishes



JAKARTA TEAK



EXTERIOLIT MARBLE PIETRO EXTERIOLIT MARBLE CARRARA EXTERIOLIT ATRIUM GREY EXTERIOLIT & COMPACT HPL SILVER FABRIC COMPACT HPL VINTAGE PINE COMPACT HPL VINTAGE FLEETWOOD



ANTIQUO OAK PINIE PONDEROSA GREY PONDEROSA WHITE STRATTOS BIANCO

# SWATCHES

## Metal Finishes

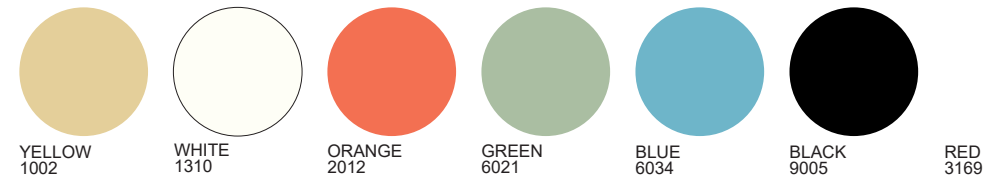

YELLOW 1002 WHITE 1310 ORANGE 2012 GREEN 6021 BLUE 6034 BLACK 9005 RED 3169

## Umbrella Canopies

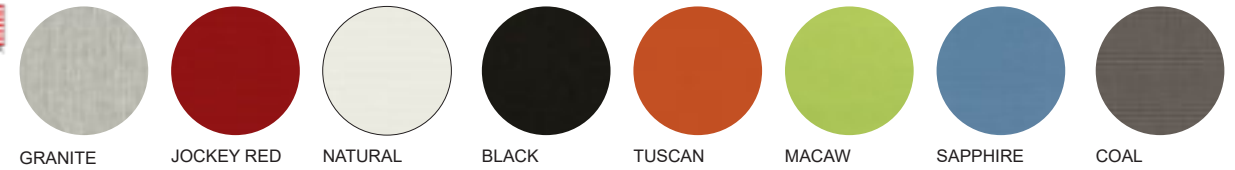

GRANITE JOCKEY RED NATURAL BLACK TUSCAN MACAW SAPPHIRE COAL

## Umbrella Frame

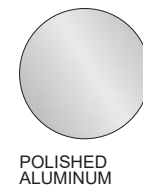

POLISHED ALUMINUM

## Umbrella Canopies

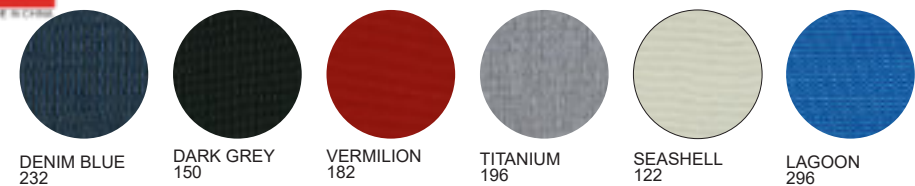

DENIM BLUE 232 DARK GREY 150 VERMILION 182 TITANIUM 196 SEASHELL 122 LAGOON 296

## Umbrella Frame

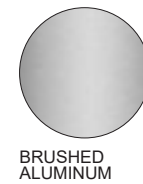

BRUSHED ALUMINUM

## Moderne Flame Finishes

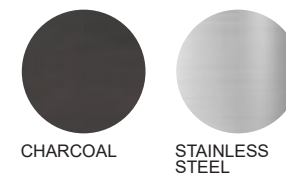

CHARCOAL STAINLESS STEEL

## Flame Finishes

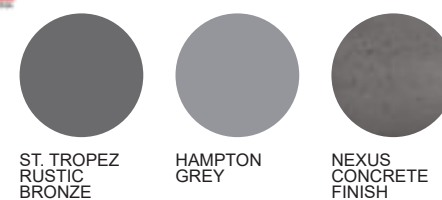

ST. TROPEZ RUSTIC BRONZE HAMPTON GREY NEXUS CONCRETE FINISH

# TERMS & CONDITIONS

## Product Dimensions/Information

All dimensions and weights shown are to be considered approximate as the majority of the products are manufactured in countries using the metric system; most measurements are converted from metric units. Bum Commercial Furniture (hereon referred to as “Bum” / “we”) reserves the right to make improvements to information displayed in our catalogue as well as our website without prior notice.

Please note that all finishes on our marketing materials and website are approximate due to variation in color monitors and the processes of photography and printing.

## Assembly

Some products require assembly; please refer to the instructions included with item packaging or visit our website for information on assembly instructions. If instructions are not available, please contact [info@bumoutdoor.ca](mailto:info@bumoutdoor.ca)

## Availability

Bum orders items in this catalogue continuously based on historical values; depending on quantity, Quick Ship items should be readily available in stock, however, may have an extended lead time in case of current sell-out, or material shortages. We strive to keep substantial quantities of our bestsellers in stock at all times.

## Special Order

Bum has access to many items outside of our Quick Ship catalogue. Special order can be placed through Bum, however those items do have a significantly longer lead time, sometimes up to 22 months for items from EMU. Please note that all special order items require a special order form to be signed as well as a 25% deposit taken (in some cases). Once orders are placed, they cannot be cancelled. Customer is responsible for 100% payment of product cost if cancelled.

## Pricing

All prices published are LIST and SELL per single unit, and do not including shipping costs, taxes or installation. Due to frequent currency and raw material fluctuations, we reserve the right to change prices without notice.

All Bum Commercial Furniture dealers (brick and mortar and online) must not sell our products for less than the sell price listed in our current year Quick Ship catalogue and website.

## Quotes

Please contact your local Bum Commercial Furniture representative for quotes. For a local rep please contact [info@bumoutdoor.ca](mailto:info@bumoutdoor.ca). All quotations received from Bum Commercial Furniture or our sales representatives are valid for 30 days unless prolonged in writing.

## Sample Requests

Fill out the sample request form on our website <https://bumoutdoor.ca/sample-request/>. Bum has the right to deny sample requests if they see fit.

## Placing of Orders

All orders are to be sent to [orders@bumoutdoor.ca](mailto:orders@bumoutdoor.ca) with your sales representative on CC (if applicable). Orders must be sent in the form of a formal purchase order. These orders are subject to acceptance by Bum. All orders must contain the following information:

[Bill to + contact name and phone number](#)

[Ship to + contact name and phone number](#)

[Proper product codes, colors and quantity required](#)

[Requested ship date or required on site date and shipping requirements \(i.e. call before, appointment delivery, tailgate delivery, white glove services\) and/or state that customer is picking up \(Bum does not guarantee delivery by those dates but will do their best to accommodate\)](#)

[Purchase order number or code](#)

## Acknowledgement

[Order acceptance will be made in the form of a sales order confirmation.](#) This confirmation will include an estimated ship date based on dates the customer has provided. If they are not provided, the “date required” will be noted as the date of the sales order entry. The sales order will also include lead times/estimated warehouse arrivals (EWA) listed on each line item if applicable.

[Sales Order Confirmations must be reviewed for corrections immediately upon receipt.](#) There will be a link provided in which the customer must click and “approve” the order. Without that being done, the order is not yet confirmed and valid. Bum will not be held responsible for any errors or missing information on sales order confirmations. All orders will ship ASAP unless otherwise noted on the purchase order. Please note: if an order is split shipped, backorder shipping charges will apply.

[Accepting the order confirmation online is the customers' acceptance of all these terms.](#)

[Once shipped, invoices are sent via email with tracking information on the day of the shipment.](#)

## Backorders

Standard shipping charges apply to all backorders. All backorders will ship once the product becomes available.

## Payments & Credit

Payment Methods Accepted: EFT / ACH / Company Cheques / E-transfers / Credit Cards (fees may apply). Returned cheques are subject to a \$100 fee NSF fee.

## Required Deposits

Each of the following requires a 25% non-refundable deposit and/or a special order form being signed:

Special Order Items

Direct Containers

Clearance Items

In the case where terms have been established with Bum, only the form is required (aside from clearance items).

## Deductions

No deductions may be made from remittance without email authorization from Bum Commercial Furniture.

## Collections

In the event of delinquency, the customer shall be responsible for all collection costs, including attorney’s fees incurred by Bum Commercial Furniture.

## Refunds

Should a refund be required due to overpayment, this may only be processed after the completion of the related purchase order. The completion of the purchase order is when the order is shipped and invoiced.

## Returns

Special order items, parts, clearance, and cushions are not returnable and non-refundable.

QuickShip items may be returned within 30 days from the invoice date with an RMA (return merchant authorization). Items must be received in their original condition, in original boxes including all original interior packaging, and palletized for a full refund (or brought directly back to the warehouse for a full refund minus a 25% restocking fee.

# TERMS & CONDITIONS

## Re-Stocking Fee

A minimum of 25% restocking fee will be charged for the return of Quick Ship items in their original condition.

[Credit for returns will only be issued after receipt and inspection of returned merchandise.](#) Damaged returns are subject to additional charges incurred to restore goods to their original condition or the customer may reclaim the items if the determined credit amount is insufficient.

No return of merchandise will be accepted to our distribution centre without our email consent and RMA number, which includes the appropriate shipping instructions.

Unauthorized returns will be refused and/or returned freight collect.

[RMA # is only valid for 15 days from the issue date.](#) A copy of the RMA must accompany the returned merchandise, and the RMA # must appear on each carton returned.

Any additional cartons needed fore turn will be charged to your account. No credit will be issued for goods without our email consent.

## Estimated Ship Date

All estimated ship dates are approximate only. Bum cannot be held responsible for financial damage due to late shipping. All orders are subject to delay or failure of delivery due to problem with source of supply, transportation, war, riots, fire, accidents, compliance with government regulations, strikes, Acts of God, or other causes beyond our control.

## Shipping

Shipping and routing instructions are required for each third-party shipment. If no such instructions are received, we have the right to ship by carrier of our choice. If billing a third-party, the payer’s discount program will take precedence; please consult your carrier for a freight quote.

Customer pickup is available from our distribution centre, a pickup appointment must be booked before arrival. The link to do that is <https://bumoutdoor.ca/pickup/>. If customers come to the warehouse without an appointment they will be turned away, missed pickups may be subject to additional fees.

## Refusals

If a shipment is refused, re-consigned, re-delivered, storage or additional services are rendered that were not mentioned at the time of the freight quote/shipment, the customer is responsible for all additional charges incurred, and applicable re-stocking fees.

## Freight Quotes

Freight quotes provided by Bum Commercial Furniture must be sent alongside any orders. If a freight estimate # is not received, freight will be requoted. Please ensure that when requesting a freight quote you send it to [freight@bumoutdoor.ca](mailto:freight@bumoutdoor.ca) with the appropriate information required and/or fill out the form on our website <https://bumoutdoor.ca/freight-quote/>. Freight quotes will be done as quickly as possible, please try to keep the number of revisions of freight requests to a minimum so we can serve as many customers as we can in a timely manner.

## Stock Hold/Storage Fees

Product cannot be reserved or held for over 30 days unless a 25% deposit is received. Orders will be held for up to 6 months. After 6 months, a storage fee of \$25+tax will be charged per pallet worth of product. This storage amount will be added to the sales order/invoice and must be paid in full before shipping/pickup or by the payment date noted on your invoice.

## Third-Party Reselling

Bum Commercial Furniture does not authorize third party reselling (the practice of an authorized Bum Dealer selling Bum to another retailer). Authorized Bum Dealers must be clearly identified and fulfil the order.

## Claims & Damages

Bum Commercial Furniture carefully packages its products and inspects them thoroughly before they leave the warehouse. Photos are also taken. It is the duty of the receiving party/consignee to inspect and receive all merchandise immediately upon arrival for any visual and/or concealed damage. Effective immediately: all freight deliveries from Bum Commercial Furniture are required to be inspected by the receiving party/consignee before the carrier leaves their facility. A signature and note of any potential damage must be clearly documented in detail on the Bill of Lading.

If freight damage is discovered after the carrier has left the facility and has not been documented on the Bill of Lading, those damages and/or replacements will be the responsibility of the receiving party/consignee. The product will not be eligible for refund or replacement by Bum Commercial Furniture.

Products with freight damage from all Third-Party and Collect shipments (including pickups) are not eligible for replacement by Bum Commercial Furniture. Customers must contact their carrier directly.

## Freight Claims & Damages

### [VIA 3rd Party](#)

If a specific carrier was requested on the purchase order, the customer takes full responsibility for all freight issues, including contacting the carrier, damages, losses, and additional freight charges, and claims.

### [VIA Carrier](#)

Before accepting and signing the merchandise from the carrier, inspect all cartons for visible or concealed damage and clearly note any loss or damage on the delivery receipt/Bill of Lading. If there is loss or damage, make an immediate claim with the delivery carrier. In the even of concealed damage, save all cartons and packing materials and notify the freight carrier and Bum Commercial Furniture immediately for inspection. Missing items/parts/hardware claims against us will be considered only if filed with us via our website <https://bumoutdoor.ca/warranty/> within 3 days of the delivery date. Failure to make such a claim shall constitute acceptance of the merchandise and waived of any defects, errors, or shortages. Bum Commercial Furniture is not responsible for damage or loss incurred in transit. All furniture is shipped at the purchaser’s own risk after it has been inspected and securely package at the distribution centre. It is accepted as such by the freight carrier.

## General Maintenance

As with any piece of equipment, proper and periodic maintenance is necessary to ensure the longevity of the product and customer satisfaction. To ensure you get the most out of your investment, please follow our recommended maintenance and care instructions.

We recommend that the products be examined every 30 days. Items requiring adjustments, showing any sign of structural failure, missing hardware, or showing any cracks at the welds should be taken out of service immediately until repaired.

Loose screws should be tightened as required and missing or worn-out foot caps must be replaced. To obtain replacement parts, please contact your local sales representative and/or [info@bumoutdoor.ca](mailto:info@bumoutdoor.ca).

Furniture should be handled with care. When chairs are stacked, the stack should not be dragged. Stackable chairs should not be dropped or slammed down when being unstacked. People should not rock back or stand on the seats.

For storage, all furniture should be stored neatly, stacked to the suggested height, and packed in a clean and dry area. Tables should not be flipped and stacked. Any standing water needs to be removed to avoid damage to the finish. Cushions that are stored for longer periods of time should be stored in a well ventilated area.

Note: warranty may be voided if proper maintenance or care is not followed. Proof of care and maintenance is required with claims being made.

## Warranty

Bum Commercial Furniture has a 3 year limited warranty on all products. The limited warranty does not apply to damage resulting from accident, alteration, misuse, tampering, negligence, abuse or normal wear and tear. All items must be properly assembled and taken care of as per instructions. Upkeep of product (i.e. replacing chair feet) is the responsibility of the customer.

Warranty is only valid if all parts that can wear (i.e. foot caps) are replaced annually. Parts must be purchased within one month of replacement time and proper maintenance must be followed. Product failure caused by lack of reasonable and necessary care and maintenance is not covered under warranty.

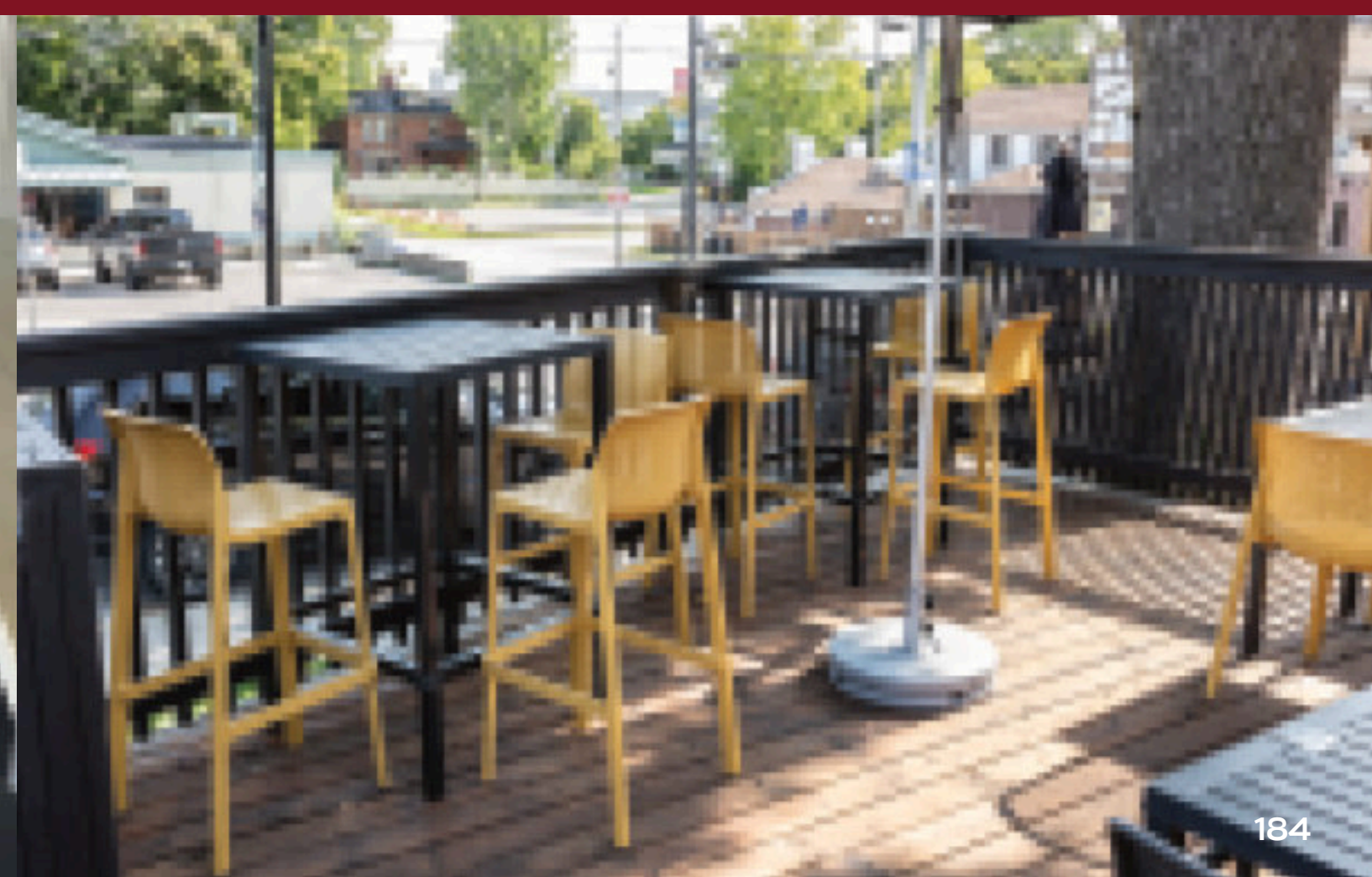
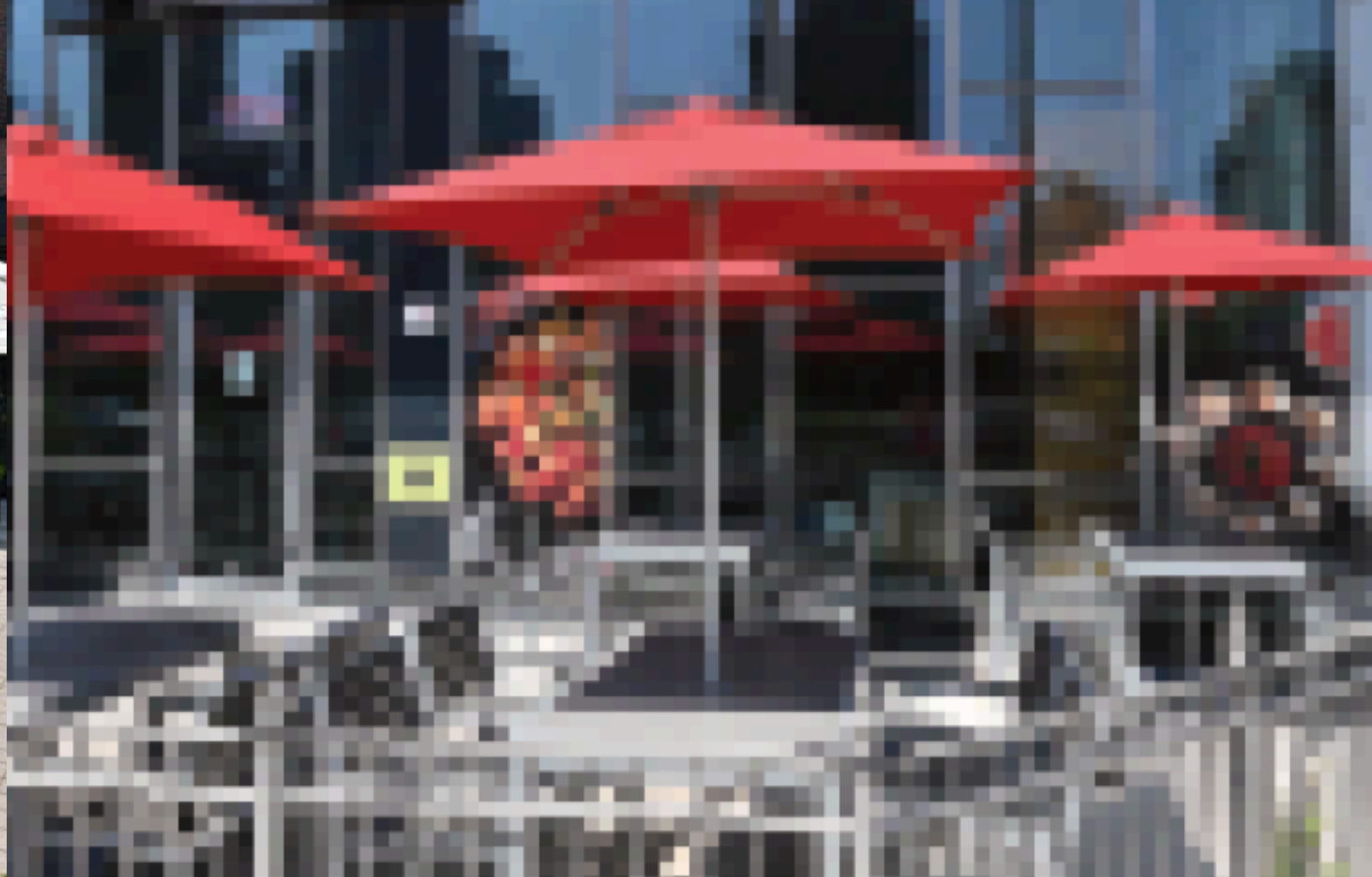

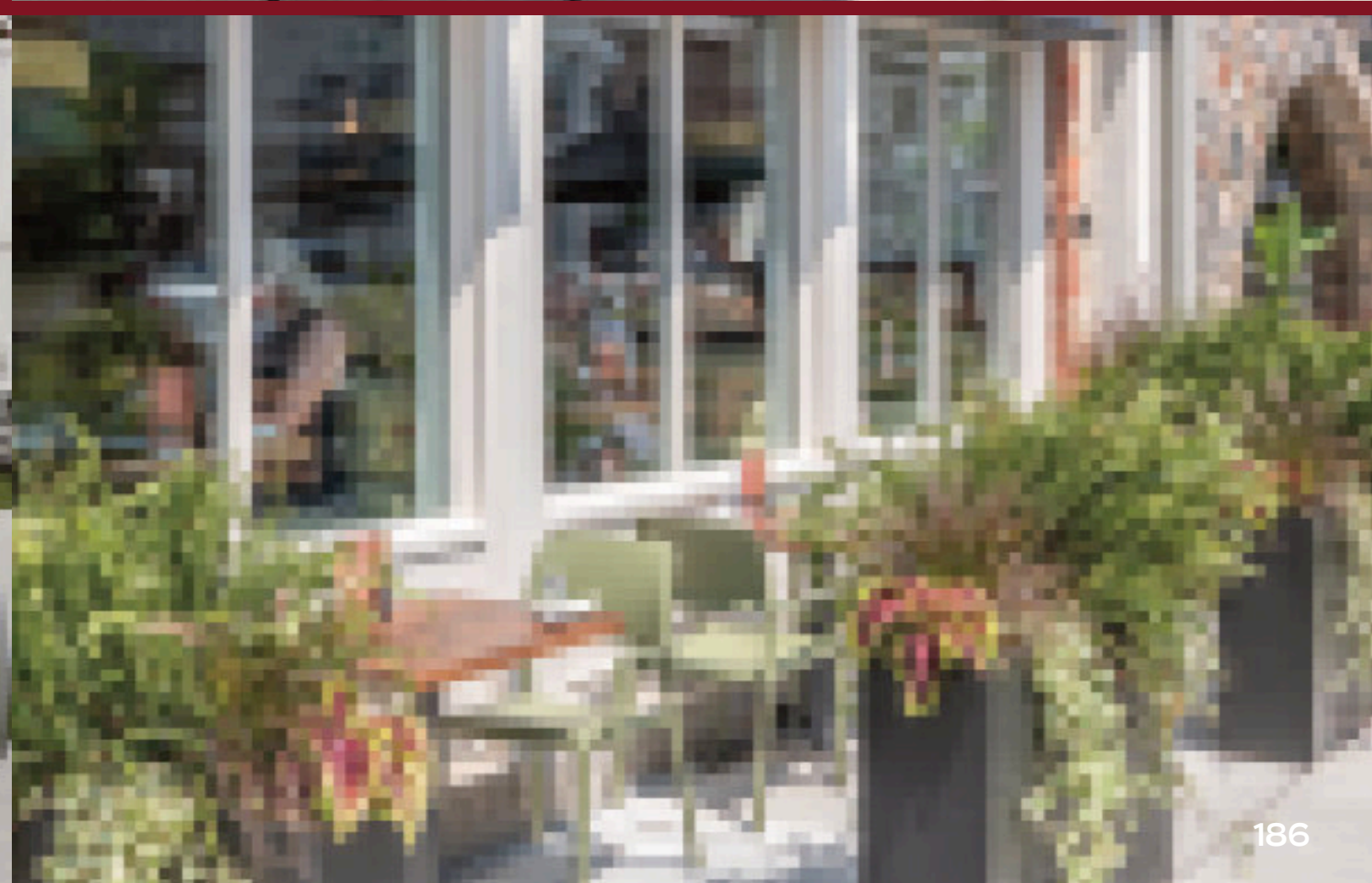



**IN STOCK READY TO SHIP**

 1-855-337-2995     [info@bumoutdoor.com](mailto:info@bumoutdoor.com)



**WWW.BUMOUTDOOR.COM**